



Polypodiophyta as sustainable and natural eco- friendly corrosion inhibitor of C-steel in the acidic environment: Experimental and adsorption characteristics

A.W. Ahmed^a, A.F. Molouk^a, A.A. El-Hossiany^{a,b}, A.S. Fouda^{a*}

^a Department of Chemistry, Faculty of Science, Mansoura University, Mansoura 35516, Egypt.

^b Delta Fertilizers Company on Talkha, Egypt; dr.ahmedselm@gmail.com.

* Email: asfouda@hotmail.com, [Tel:+2 050 2365730](tel:+20502365730)

Received: 9/5/2023
Accepted: 6/6/2023

Abstract: The corrosion protection of C-steel in 1 mol. L⁻¹ HCl solutions utilized by environmentally eco-friendly green plant extract (Polypodiophyta) was demonstrated by experimental methods as chemical approaches and electrochemical techniques. The outputs indicate that C-steel in aqueous 1 M HCl solution may be effectively prevented from corroding by using the extract solution, with effectiveness of inhibition reaching 96.2% at higher dose of 300 mg L⁻¹ and the higher applied temperature (55°C). Polypodiophyta extract, which is consistent with Langmuir isotherm, was partially chemically adsorbed on the surface of the C-steel. On the other hand, electrochemical results showed that polypodiophyta is efficient inhibitor with efficiency reached to 91 % at 300 mg L⁻¹ at 25°C. Polarization research exhibits that the extract acts as mixed hindrances. With the extract double layer capacity reduces and charge transfer resistance rises in a solution of 1 mol. L⁻¹ HCl. The outer part morphology of C-steel surfaces and the adsorption of hindrances on C-steel outer part can be checked by atomic force microscopy (AFM), and Fourier transform infrared spectroscopy (FTIR), the metal surface was developed a layer of adsorbed extract that shields it from acidic corrosion.

keywords: C-steel; Corrosion inhibition; Polypodiophyta extract; EIS; PP; HCl; AFM; FTIR.

1. Introduction

C-steel and its alloys have widely used in industrial applications, like petroleum refineries equipment, tanks construction, pipes, etc [1]. Acids are widely used in different processes in industry, hydrochloric acid have aggressive behavior so the main problem that face C- steel is high reactivity in acidic medium [2-3].

In addition to being costly, deterioration is dangerous. Billions of dollars are spent annually to repair rusted structures, machinery, and parts. Prior failure may result in the loss of life and harm to security. The amount of rusting on the surface of a metal can be reduced and regulated by adding chemical compounds to a corroding. Utilizing inhibitors provides the most effective way to prevent metal dissolution. When a small amount of a chemical is introduced to a corrosion environment, the metal's rate of deterioration is reduced by the

corrosion protection. When applied to corrosive media, dissolution hindrances reduce oxidation while preserving the outer part of the metal [4-9]. When existing in solution, organic molecules with heteroatoms (O, S, N, and P), aromatic rings, and -bonds reduce the dissolution of several metals. By adsorption (chemical and/or physical adsorption), these organic chemicals can establish a good defensive coating on the metal substrate. The contact of the steel and the inhibitory particles results in the formation of the protective barrier on the metal surface [10-12]. The components of natural products that adhere to the metal's surface are affected by a variety of variables such as: (i) chemical construction of inhibitors, (ii) metal charge, and (iii) surface nature. Compounds derived from plants with heterocyclic components such as steroids, alkaloids and flavonoids evaluated productive inhibition properties of corrosion [13-14].

Dissolution is basically an electrochemical formation that includes a combination of anodic and cathodic responses taking put at the same time on a metal surface [15]. For numerous a long times, Dissolution is the foremost challenging issues for varied mechanical divisions, because it exposes the toughness of metallic components and security on several events [16-17]. Moreover, these extracts are considered to be environmentally safe products and biodegradable. There are several studies on the natural products used as corrosion protection. Numerous plant extracts are utilized in acidic solutions as C-steel corrosion prevention methods [18-21]. A division of the plant kingdom, commonly called the ferns, which is widely distributed throughout the world but is most abundant and varied in moist, tropical regions. The Polypodiophyta are sometimes treated as a class Polypodiopsida of a broadly defined division Tracheophyta (vascular plants).

The aim of current paper is the use of plant extract (Polypodiophyta) as corrosion inhibitor because of low cost, easily available, source for obtaining is renewable, environmental friend and presence of many organic and inorganic compound containing sulphur, nitrogen and oxygen in their structures as active centers. Experimental procedures such as mass reduction, electrochemical estimations, and outer surface check of C-metallic specimens by means of AFM, SEM and EDX methodologies.

2. Materials and methods

2.1. Materials and chemicals

The compositions of the C-steel samples used in the investigation are as follows: C (0.2), Si (0.002), Mn (0.9), P (0.008), as percent weight, and the remaining percent is for Fe. Mechanical polishing was performed on C-steel specimens with dimensions of (2.1 x 2.1 x 0.2) cm. Bidistilled water was used to clean the samples after they had been with emery paper of grades ranging from 200 to 2000. The surface was cleaned with acetone, and then it was dried using filter sheets. The 1 mol. L⁻¹ HCl solution (from analytical reagent grades), created by using bidistilled water for dilution, is the acid medium employed for this study.

2.2. Inhibitor's preparation

The plant was dried and grained to fine

powder using an electrical mill at room temperature. "200 mg of Polypodiophyta powder was soaked in 800 ml of methanol. The extract was removed and dried by rotary evaporator. The extract liquefied in absolute ethanol and few ml from DMSO. 1000 mg L⁻¹ stock solutions from the investigated inhibitor were prepared by dissolving one gram /liter of the solid pharmaceutical drug in bi-distilled water; the other concentrations (50 – 300 mg L⁻¹) were prepared by dilution with bi-distilled. "The chemical compounds that are present and absent in each of the plant extracts after the phytochemical analysis was successfully carried out on the plant extract. The results show that extract contained the following chemical constituents; Alkaloids, Tannins, Saponins, Phenols, Terpenoids, Quinones", Cardiac Glycosides except for Flavonoids, Carbohydrates and Glycosides [22].

2.3. Methods

2.3.1. Chemical measurements

A. Weight reduction (WR) Measurements

The weight reduction estimations were applied on C-steel with measurement (2.1cm x 2.1cm x 0.2cm) at distinctive temperature (25, 35, 45, and 55 °C) by deciding the mass of the specimens sometime recently and after drenching in 1.0 mol. L⁻¹ HCl medium within varied doses of hindrance for (6h). The C-steel tests were arranged in one size in all estimations and the outsides was cleaned employing a distinctive arrangement of coarseness emery paper (200, 400, 600, 1000, 1200, 2000), at that point cleaned in refined water, dried at room temperature and weighed some time recently setting within the test arrangement by expository adjust measuring. After accomplishing the submersion time (1h), The IE (%), corrosion rate (k_{corr}) and surface coverage (θ) was computed by the next formulas [23]:

$$\% IE = \theta \times 100 = [1 - (W_1/W_2)] \times 100 \quad (1)$$

$$k_{corr} = W/At \quad (2)$$

where W and a are respectively the reduction of mass (mg) and (A) the surface area (cm²) of the specimen, W₁ and W₂ are the dissolution rate (mg cm⁻² min⁻¹) of the C-steel in the existence and non-existence of Polypodiophyta extract, and separately t is the time in minutes.

2.3.2. Electrochemical measurements

Two strategies, specifically electrochemical

impedance spectroscopy (EIS) and Tafel polarization were utilized to study the dissolution attitude of carbon steel in 1.0 mol. L⁻¹ HCl within varied doses of Polypodiophyta extract at (25°C). “Electrochemical tests were contacted in an ordinary electrochemical cell device, in which a soaked calomel terminal (SCE) worked as a reference cathode, a platinum wire as an assistant anode and C-steel as a working terminal with a surface zone of 1.0 cm². The working cathode (C-steel) was manufactured from the same sort of C-steel utilized for the WL method. Earlier electrochemical measurements, the working anode was arranged taking after the same arrangement strategy, at that point the C-steel anode is submerged within the test arrangement for 30 min to start a consistent state open circuit potential (OCP). The Tafel polarization trial was applied within the potential extend of -600 to +200 mV vs. OCP with a check rate of 0.5 mV S⁻¹ [24]. The PP corrosion variables, overall dissolution current density (*i*_{corr}), dissolution potential (*E*_{corr}), anode Tafel (*β*_a) and cathode Tafel (*β*_c) slopes were gotten via Tafel extrapolation procedure. EIS estimations were applied in the frequency estimate of 10 kHz to 10 mHz and with sine wave peak-to-zero voltage of 10 mV amplitude at (OCP)”. All electrochemical examinations were applied at (25°C) and carried out 3 times for accuracy purposes.

The IE and (θ) were planned from the following balance:

$$\% IE = \theta \times 100 = [1 - (i_{corr(inh)} / i_{corr(free)})] \times 100 \quad (3)$$

Where the densities of the corrosive current (*i*_{corr}) without (*i*_{corr(free)}) and with (*i*_{corr(inh)}) Polypodiophyta extract, correspondingly.

EIS tests were achieved utilizing the same cell that used in polarization investigates. In EIS tests, the potential of open circuit (OCP) and AC current signal of 10 mV peak to peak have been used between 1 Hz and 100 kHz in frequency. The amount of surface coverage (θ) and percent inhibitory effectiveness (% IE) can be computed by employing the following Eq.:

$$\% IE = \theta \times 100 = [1 - (R_{ct}^{\circ} / R_{ct})] \times 100 \quad (5)$$

with *R*_{ct}^o= resistance of charge transfer without Polypodiophyta extract and *R*_{ct}= resistance of charge transfer with

Polypodiophyta extract.

2.3.3 Surface Examinations

2.3.1 Fourier-transform infrared spectroscopy (FT-IR) analysis

Technique of FTIR analysis is used to detect the functional groups of the inhibitor before and after metal immersion via peaks with certain values. The Attenuated Total Reflectance (ATR) method can be applied to examine the FTIR spectra of 300 mg L⁻¹ of Polypodiophyta extract in 1M HCl prior to and following C-steel inundation for 24 hours by apparatus of FTIR-Spectrometer iS 10 (Thermo Fisher Scientific, United States of America).

2.3.2 Atomic force microscope

The AFM procedure was utilized to bring photomicrograph and compute the outsides harshness of C-steel checks in the nonattendance and nearness the ideal dosage of Polypodiophyta extract. The AFM was managed in connection manner utilizing a test on non-conductivity silicon using the nanosurf C300 program (adaptation 3.5.0.31).

3. Results and Discussion

3.1 Chemical Measurements (WR)

WR of C-steel was tested at 25 ± 1°C after three hours of flood in 1 mol. L⁻¹ HCl solution without and at different Polypodiophyta extract concentrations and presented in Fig. 1, % IE, was calculated from Eq. (1), All the experiments are performed at 25-55°C. Values of corrosion rates (*k*_{corr}) and % IE of Polypodiophyta are recorded in (Tables1&2). The 300 mg L⁻¹ concentration achieves an efficiency of 91% at 25 C and 96.2 % at 55 C. It was shown that as the Polypodiophyta extract concentration raised, its performance improved due to an increase in inhibitory efficiency and a decrease in *k*_{corr}. The increase in Polypodiophyta extract adsorption and surface coverage on C-steel surface as extract concentration grew may be the cause of the decreased *k*_{corr}. The Polypodiophyta extract adsorbed layer isolates C-steel from acidic solutions and inhibits its corrosion. The results indicate that Polypodiophyta is a highly effective inhibitor of CS in HCl solution. Results showed that Polypodiophyta had a very good effect on preventing corrosion of CS in a 1 mol. L⁻¹ HCl solution as corrosive media.

Table 1 Effect of polypodiophyta doses on (CR) and (% IE) for CS in 1 mol. L⁻¹ HCl at altered temperatures and at 300 min dose

Temp	Conc, mg L ⁻¹	CR(mg/cm ² /min)	%IE
25	Blank	0.0238±0.00111	---
	50	0.0044±0.00018	81.7
	100	0.0037±0.00016	84.4
	150	0.0035±0.00012	85.2
	200	0.0028±0.00010	88.2
	250	0.0024±0.00013	89.7
	300	0.0020±0.00014	91.6
35	Blank	0.0472±0.00210	---
	50	0.0076±0.00017	83.9
	100	0.0071±0.00016	84.9
	150	0.0057±0.00015	87.8
	200	0.0053±0.00018	88.7
	250	0.0045±0.00015	90.5
	300	0.0034±0.00012	92.8
45	Blank	0.0850±0.00141	---
	50	0.0128±0.00015	84.9
	100	0.0106±0.00012	87.5
	150	0.0088±0.00013	89.6
	200	0.0079±0.00017	90.7
	250	0.0068±0.00015	92.0
	300	0.0050±0.00015	94.1
55	Blank	0.1983±0.00182	---
	50	0.0233±0.00013	88.2
	100	0.0177±0.00011	91.1
	150	0.0153±0.00015	92.3
	200	0.0110±0.00014	94.5
	250	0.0090±0.00016	95.4
	300	0.0075±0.00012	96.2

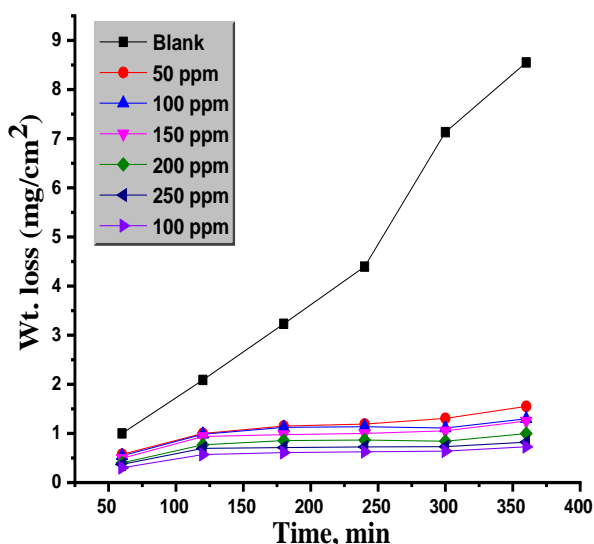

Fig.1 WR of C-steel vs. time in 1 mol. L⁻¹ HCl without and with different Polypodiophyta doses of at 25°C

3.1.1 Effect of temperature

Table 1 shows % IE against conc. of Polypodiophyta extract at altered temperatures (25- 55°C) for C-steel in 1M HCl. WR method results (k_{corr} , θ and % IE) at different

concentrations of Polypodiophyta extract at the applied temperatures were shown in **Table 1**. It is obvious that by increasing the temperature, the extract inhibitory effectiveness increases, this implies that more extract molecules have stronger adsorptive interactions with C-steel/solution interface at higher temperature. This producing a protective layer of the inhibitor on the metal surface prohibits corrosion. An increase in the extract inhibitory effectiveness as temperature rises is a sign that the extract species have chemically adsorbed to the surface of the C-steel. The corrosion process activation energy (E_a^*) can be attained by applying the Arrhenius eqn. as shown below:

$$k_{corr} = A \exp(-E_a^*/RT) \quad (5)$$

with $R = 8.314$ Joule/ mol. K, A is Arrhenius pre-exponential multiplier. Figure 2 indicates plotted between $\log CR$ and $1/T$ for C-steel in 1 M HCl without and at different Polypodiophyta extract concentrations. The E_a^* value could be gotten from the straight lines slopes. Another type of transition state expression can be

employed to attain the enthalpy (ΔH^*) and the entropy (ΔS^*) of the activation mechanism as indicated below [25-27]:

$$k_{corr} = RT/Nh \exp (\Delta S^*/R) \exp (-\Delta H^*/RT) \quad (6)$$

where h and N as constant of Planck and number of Avogadro, respectively. Straight lines were attained from the graphs of $(1/T)$ and $(\log CR/T)$ (Fig. 3). From the intercepts and slopes of the lines, ΔH^* and ΔS^* can be obtained, respectively. The attained E_a , ΔH^* and ΔS^* parameters were given in Table 2. It was found out that the inhibited solutions' E_a values are lower than that for a blank solution. The decrease in E_a indicates that the Polypodiophyta particles have chemisorbed onto C-steel surface. ΔH^* indicates that the activation mechanism is endothermic through its positive sign. The smaller values of ΔH^* in inhibited solutions compared to a blank solution, implies that the corrosion reaction energy barrier is lowered. The negative values of ΔS^* points out that association occurs in the activated complex rather than dissociation, in other words, the change from the reactant until the activated complex includes a decrease in the disorder.

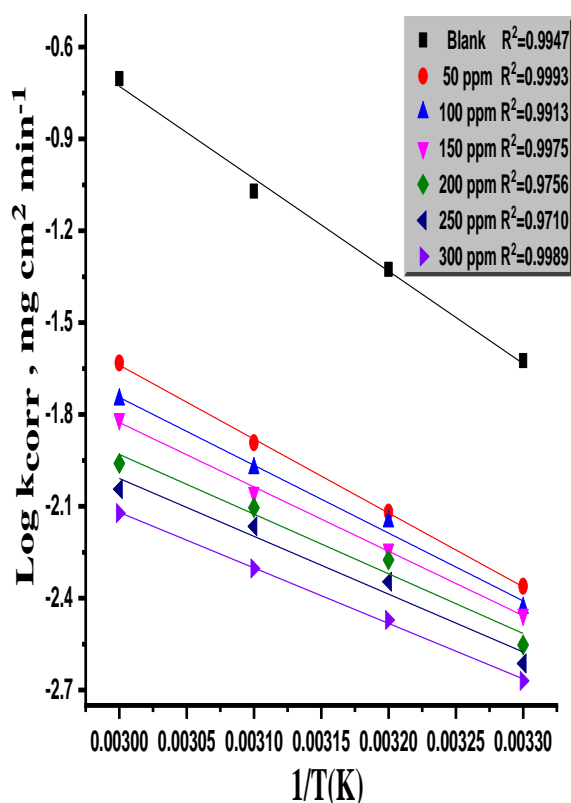

Fig. 2 Arrhenius graph of C-steel in 1 mol. L⁻¹ HCl with and absence Polypodiophyta at different temperatures (25-55°C)

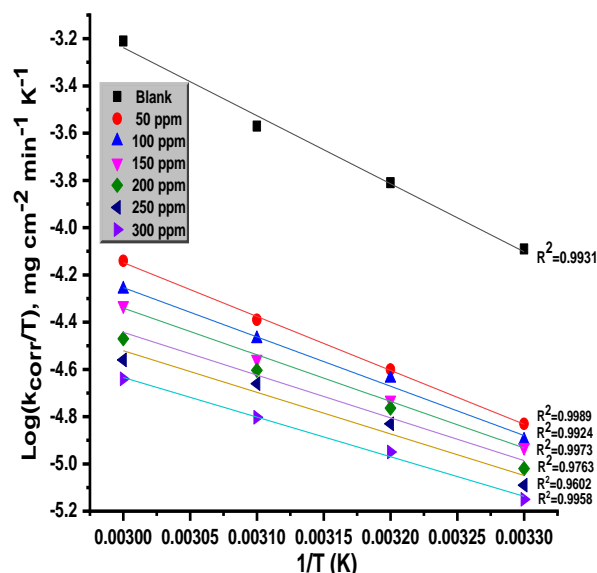

Fig. 3 Log (k_{corr}/T) versus $1/T$ for C-steel in 1 mol. L⁻¹HCl without and at altered temperatures (25-55°C)

Table 2 Thermodynamic activation factors for C-steel without and at different extract concentrations in 1 mol. L⁻¹ HCl solution

Conc., mg L ⁻¹	Activation parameters		
	E_a kJ mol ⁻¹	ΔH^* kJ mol ⁻¹	$-\Delta S^*$ J mol ⁻¹ K ⁻¹
Blank	57.7±0.2021	55.1±0.2312	192±0.2104
50	46.2±0.2309	43.6±0.1453	194.8±0.2027
100	42.4±0.2333	39.9±0.2729	195.4±0.2603
150	0.2±0.2404	37.7±0.1453	195.9±0.2333
200	37.3±0.2028	34.6±0.1764	196.5±0.1856
250	36.1±0.2048	33.6±0.1453	196.7±0.1453
300	34.6±0.1732	32.1±0.2646	197.1±0.1764

3.1.2. Adsorption isotherms

Adsorption isotherms are frequently used to describe an inhibitor's efficacy. To acquire essential crucial data regarding the corrosion inhibition process, adsorption isotherms might be used. Numerous adsorption isotherms were tested [28-29], and Langmuir isotherm, which agrees with the following equation, was the best one.

$$C/\theta = 1/K_{ads} + C \quad (7)$$

where C = concentration of extract, a = the attractive parameters and K_{ads} = adsorption constant. Plots of Langmuir isotherm appears in Fig. 4. It is possible to acquire the free adsorption energy (ΔG°_{ads}) by applying the following Eq.:

$$K_{ads} = (1/55.5) \exp (\Delta G^{\circ}_{ads} / RT) \quad (8)$$

with 55.5 as the molarity of water in the solution. Van't Hoff plot (Fig. 5) is a simple way to both qualitatively and quantitatively

measure the enthalpy of the adsorption process (ΔH°_{ads}), according to the following Eq.:

$$\log K_{ads} = \frac{-\Delta H^{\circ}_{ads}}{2.303RT} + \text{constant} \quad (9)$$

Using the fundamental thermodynamic principle equation, the entropy of adsorption (ΔS°_{ads}) may be determined as follows:

$$\Delta G^{\circ}_{ads} = \Delta H^{\circ}_{ads} - T\Delta S^{\circ}_{ads} \quad (10)$$

The different adsorption process thermodynamic functions (K_{ads} , ΔG°_{ads} , ΔH°_{ads} and ΔS°_{ads}) are described in (Table 3). " ΔG°_{ads} are negative and grew as the percentage IE rose, indicating that the studied extract is heavily adsorbed on the surface of C-steel. These results further demonstrate the spontaneity of the adsorption procedure and the stability of the adsorbed layer on surface of the C-steel. It known that values of ΔG°_{ads} lower than 20 kJ mol⁻¹ indicate of physical adsorption [30]. The K_{ads} follows the similar pattern in that higher K_{ads} values indicate better, more effective adsorption and, hence, stronger inhibitory effectiveness. The extract adsorption from a 1 mol. L⁻¹ HCl solution onto the surface of C-steel is revealed to be an exothermic process by the negative sign of the ΔH°_{ads} equation, which means that the extract % IE rises as the temperature grew. Such attitude can be discussed by the reality that as temperature grows, more inhibitor molecules adsorbed onto the metal's surface, leading to the observation of higher protection". It was shown that the entropy of adsorption (ΔS°_{ads}) exhibits negative indicators, indicating that the disorder is diminished in conjunction with the adsorption process.

Table 3 Parameters of adsorption of Polypodiophyta extract on the surface C-steel at different temperatures

Temp ^o C	K_{ads}, mol^{-1}	$-\Delta G^{\circ}_{ads}, \text{kJ mol}^{-1}$	$-\Delta H^{\circ}_{ads}, \text{kJ mol}^{-1}$	$-\Delta S^{\circ}_{ads}, \text{J mol}^{-1} \text{K}^{-1}$
25	90.0±0.1453	21.09±0.1453	10.79±0.1563	106.9± 0.2028
35	93.4±0.1732	21.9± 0.2028		106.1± 0.1732
45	105.9±0.1453	22.9±0.1732		105.9±0.2128
55	132.0±0.1243	24.2± 0.1000		106.6±0.1453

3.2 Electrochemical tests

3.2.1 PP tests

Tafel estimations were applied to get main data on the potential of anodic and cathodic responses. Tafel bends of the C-steel in 1.0 mol. L⁻¹ HCl medium within varied doses of Polypodiophyta extract at 25°C are appeared in Fig. 6. Electrochemical dissolution variables

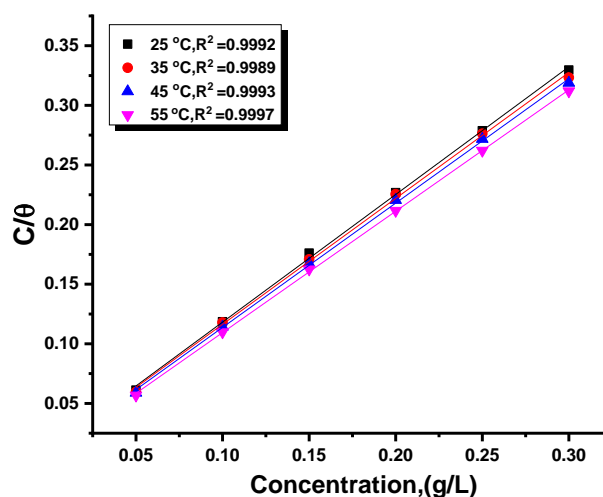

Fig. 4 Langmuir graph for Polypodiophyta extract at altered temperatures for C steel in mol. L⁻¹ M HCl

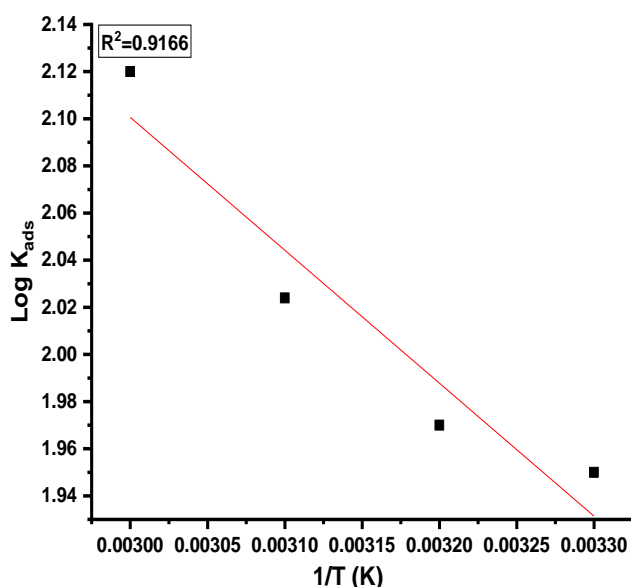

Fig. 5 Log K_{ads} vs $(1/T)$ for dissolution of C steel in 1 mol. L⁻¹ HCl in the presence of Polypodiophyta

like dissolution potential (E_{corr}), dissolution current (i_{corr}), Tafel incline constants (β_a , β_c) and inhibition proficiency (IE %) are computed from the extrapolation of the polarization graphs appeared in Fig. 6 and placed in Table 4. The (%IE) and (Θ) were designed from Eq. (5) [31-32]. Table 4 appears that dissolution

current densities diminished and hindrance productivity values expanded with increasing inhibitor doses, talking to that accumulation of the extract molecules on the metal surfaces and blockage of active sites [33]. In the event that the change within the E_{corr} is less than 85 mV per SCE; it is appeared a mixed kind inhibitor [34]. In our study, the displacement was less than 85 mV this demonstrates that the examined Polypodiophyta extract acts as a mixed sort inhibitor. The Tafel lines are parallel indicating that there no mechanism change. It is well known that the activation barrier's

Table 4 PP measurements of C-steel dissolution in 1 mol. L⁻¹ HCl within varied dosages of Polypodiophyta at 25°C

Conc, ppm	i_{corr} , mA cm ⁻²	$-E_{corr}$, mV vs SCE	β_a (mV dec ⁻¹)	β_c (mV dec ⁻¹)	k_{corr} mpy	θ	% IE
0.0	233.0± 0.2028	463± 0.1732	65.0± 0.2309	81.1±0.1453	233.0	---	---
50	42.8±0.2431	451±0.1732	121.9±0.2028	185.6±0.2906	42.8	0.816	81.6
100	42.3±0.2055	458±0.2309	114.9±0.1364	179.0±0.2028	42.3	0.818	81.8
150	35.4±0.1742	459±0.1202	118.3±0.1732	167.5±0.2082	35.4	0.848	84.8
200	28.0±0.2010	463±0.1453	110.0±0.1532	172.5±0.1732	28.0	0.879	87.9
250	26.8±0.1208	435±0.2027	71.3±0.2028	140.0±0.2082	26.8	0.884	88.4
300	20.7±0.1452	448±0.1764	82.6±0.2010	121.6±0.1764	20.7	0.911	91.1

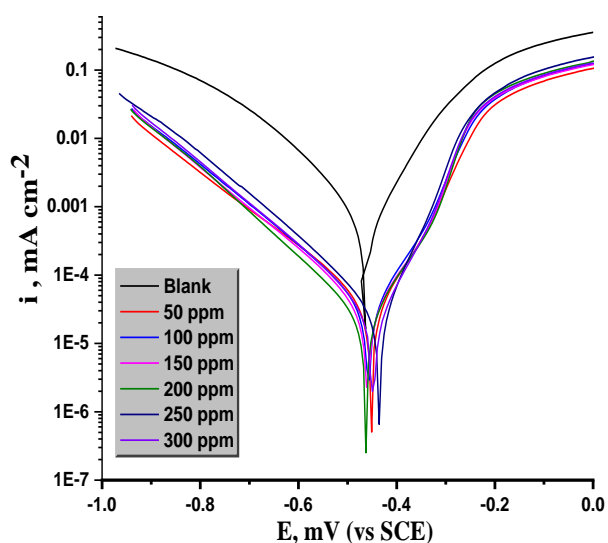

Fig. 6 Tafel polarization bends of C steel corrosion within changed dosages of Polypodiophyta at 25°C

3.2.2. EIS tests

EIS is an effective and useful method. A lot of details can be obtained from impedance diagrams, such as kinetic parameters, surface properties, and mechanistic information [35]. The Nyquist and Bode charts for C-steel in 1 mol. L⁻¹ HCl at 25°C were displayed in Figs. 7 & 8, respectively, at open-circuit potential without and at different Polypodiophyta extract concentrations. “The heterogeneity of the working electrode may be responsible for the

symmetry for anodic and cathodic reactions is measured by the Tafel lines (β_a and β_c). As was already established, the addition of extract did not significantly alter the cathodic or anodic curves' shapes. The extract film therefore had an equal impact on cathodic and anodic responses. Therefore, the corrosion mechanism is unaffected by the presence of different Polypodiophyta concentrations. The experimental Tafel graph results and the data collected for weight reduction were in excellent agreement

observed semicircles' characteristics”. It has been noted that the addition of extract changed the charge transfer rate, which led to an increase in the semicircle's diameter. “Comparing the Bode charts (Fig. 8) to those of the free acid, their magnitude increased”. This could be explained by the extract molecules adhering to the surface of the C-steel [36]”. The electrical circuit equivalent model that applied on EIS results was seen in the Fig. 9. Different EIS parameters were computed and included in Table 5. It found that there is a growth in (R_{ct}) values while there was a gradually drop in (C_{dl}) values as concentration of Polypodiophyta extract increases. This may be a result of the extract gradually replacing molecules of water through the adsorption on the metal surface or a result of thickening the double layer. This could be explained by the frequency dispersion brought on by the electrode surface's heterogeneity [37].

“The findings in Table 8 make it clear that the R_{ct} and R_s values of inhibited systems are higher than those of uninhibited systems. With an increase in inhibitor concentration, these values rise”. The higher R_{ct} and R_s values in the HCl solutions containing Polypodiophyta extract when the blank signifies a slower rate of corrosion response [38]. “The improved

resistivity to electrochemical corrosion at high inhibitor dose is consistent with the increased R_{ct} and R_s values with increasing Polypodiophyta extract dose [39]". The Table also shows that n value directly correlates with inhibitor concentration, whereas Y_0 does not. n value is a measure of surface roughness [40]", and in this study, an increase in it might indicate a reduction in the heterogeneity of the working electrode surface brought on by the adsorption of inhibitor molecules. "The chi-squared statistic was used to assess the accuracy of the fitting findings; tiny chi-squared values (Table 8) obtained for each result demonstrate that the fitted results and experimental fittings agree very well".

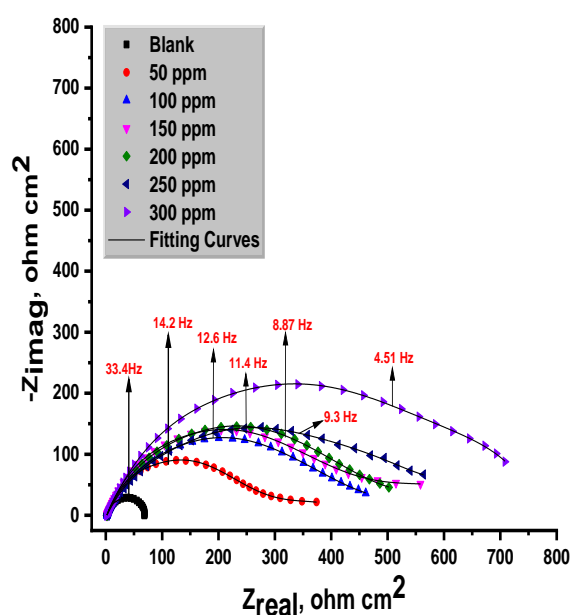

Fig. 7 Nyquist graphs for C-steel destruction within varied amounts of the of Polypodiophyta at 25°C

Table 8 EIS results of C-steel dissolution in the attendance of varied amounts of the Polypodiophyta extract at 25°C

Conc, mg L ⁻¹	R_{ct} Ω cm ²	R_s Ω cm ²	Y_0 , μΩ ⁻¹ s ⁿ cm ⁻²	n	C_{dl} , μF cm ⁻²	θ	% IE	Goodness of fit (χ^2)
Blank	68.96±0.1453	2.347±0.1732	360	0.729	204	---	---	1.509x10 ⁻³
50	288.3±0.1764	1.787±0.2333	339	0.738	189	0.76	76.0	9.476x10 ⁻³
100	418.8±0.2309	2.085±0.1453	321	0.753	183	0.835	83.5	7.504x10 ⁻³
150	452.8±0.2028	1.923±0.1214	318	0.762	173	0.847	84.7	7.521x10 ⁻³
200	463.2±0.1732	2.030±0.1453	315	0.782	167	0.851	85.1	7.050x10 ⁻³
250	510.50.2028	2.288±0.1353	310	0.799	161	0.864	86.4	8.087x10 ⁻³
300	681.0±0.2309	1.828±0.1145	269	0.867	143	0.898	89.8	8.335x10 ⁻³

3.3 Surface Examinations:

3.3.1 AFM analysis

AFM technique supplies photos with atomic or near-atomic-resolution surface topography which able to giving the surface roughness of

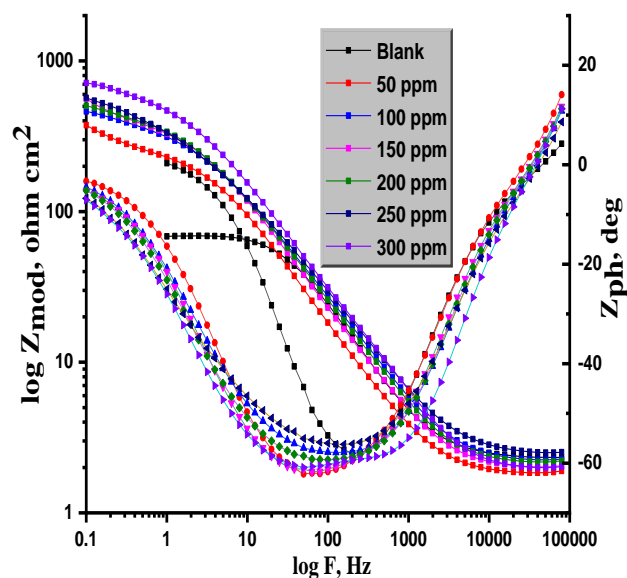

Fig. 8 Bode graphs for C-steel destruction within varied amounts of the of Polypodiophyta at 25°C

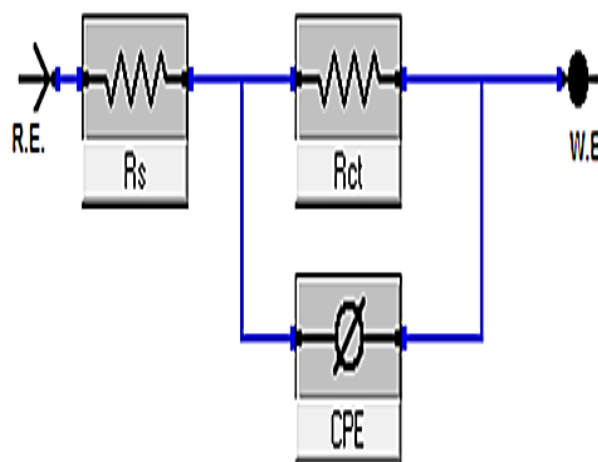

Fig. 9 Equivalent circuit utilized to provide investigated EIS outcomes

coupons by the angstrom-scale [41]. This technique is an effectual mode to examine the surface analysis of uninhibited and inhibited surfaces of carbon steel. 3-D AFM picture of the outer parts of carbon steel consumed in 1 mol. L⁻¹ HCl for 24 h are displayed in Fig.11

with and without the optimal Polypodiophyta extract amount checked. The common roughness of the surface of C-steel after dipping for 24 hours performed in Fig.10 a 3-D photo of the C-steel surface placed in 1 mol. L⁻¹ HCl without inhibitors for 24 h and the common roughness become calculated to be 357.44 nm and Fig.10 (b) appears the 3D picture of the C-steel surface within the highest dose (300 ppm) of the Polypodiophyta extract, the roughness to 79.13 nm. This results approach shows the collecting of Polypodiophyta extract on the surface of C-steel and procedure of a protective film on C-steel surface.

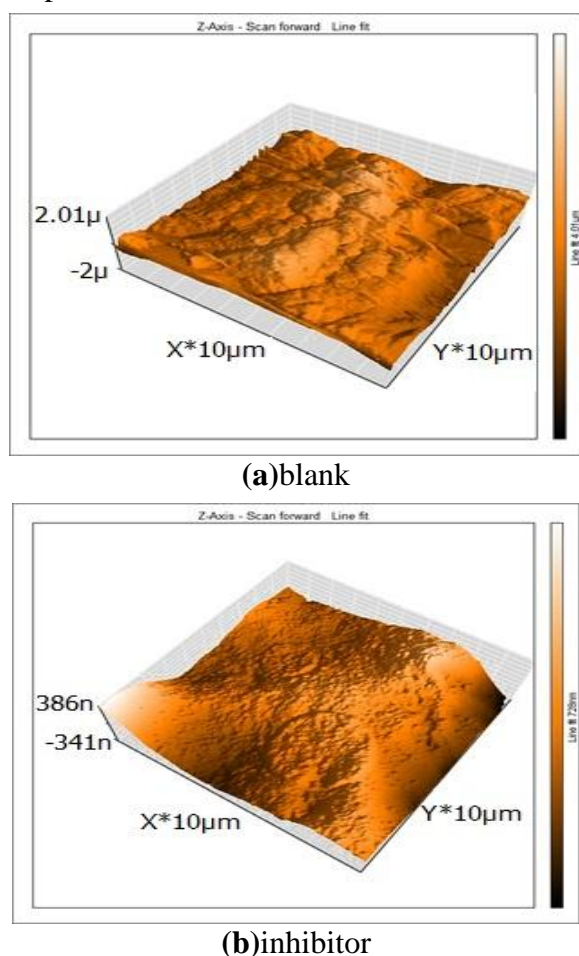

Fig. 10 AFM analysis on C-steel with and absence of Polypodiophyta for 24 hours immersion

3.3.2 AFTIR analysis

FT-IR method identified specific peaks in the extract IR spectra that corresponded to the functional groups. The FT-IR spectra of the Polypodiophyta inhibitor prior to and following C steel immersion were shown in Fig. 11. The finger print spectra of the extract stock and the C-steel surface were obtained and compared to

one another after being dipped in 1 mol. L⁻¹ HCl + 300 mg L⁻¹ of

Polypodiophyta for 6 hours [42]. It was immediately apparent that the finger print of extract stock solutions was present on the C Steel surface, with the exception of the absence of some functional groups, which was likely caused by a reaction with HCl. Small variations in the peaks at the surface of the C-steel shown in Fig. 11 relative to the peak of the stock inhibitor solution show that the C-steel and inhibitor molecules are interacting.

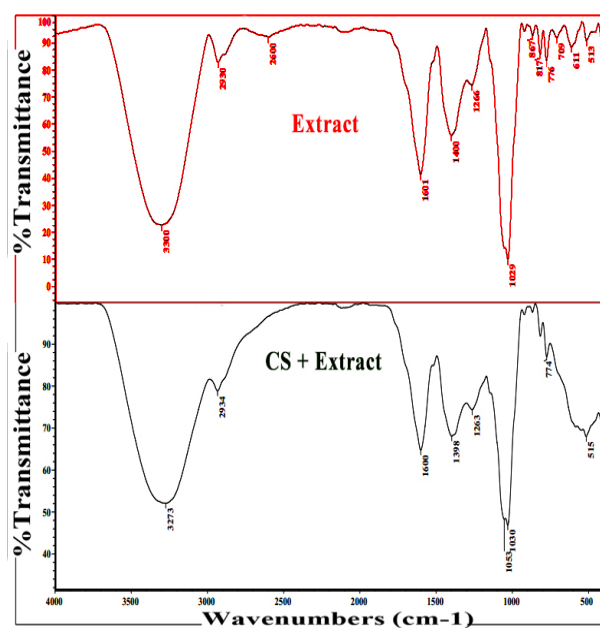

Fig. 11 IR spectrum of pure Polypodiophyta and with C-steel at 25⁰C

3.4. Mechanism of corrosion inhibition

The presence of a polar unit with nitrogen, oxygen, and sulphur atoms is what causes the adsorption of extract molecules. Corroding appears through two fundamental responses, the oxidation response and the reduction of hydrogen. The corrosion prevention procedure takes place by diminishing both reactions. The inhibition mechanism will be attributed to the accumulating of the Polypodiophyta extract on the C steel surface. The adsorption procedure can be chemical (chemisorption) or physical (physisorption) adsorption. In our work, the accumulating of Polypodiophyta on the surface of C-steel is chemical adsorption with partially physical contribution of lone electron pairs from heteroatoms to the vacant d orbital of the metal which forms a covalent bond with the surface of C steel [43]. The investigated Polypodiophyta extract contains numerous compounds with a lot of heteroatoms and aromatic rings. These compounds create

coordination bonds with Fe's free d-orbital, and act as a barrier contra surroundings that causing corrosion [44, 46].

4. Conclusions

Polypodiophyta extract appears to have a strong inhibitory efficiency for C-steel corrosion and the process of protection was fundamentally illuminated by the adsorption. Polypodiophyta extract adsorption on a surface of C-steel followed the Langmuir adsorption isotherm. The percentage of IE rises with increased extract dosage and increased temperature. From a polarization investigate; it appears that Polypodiophyta extract acts as mixed-type inhibitor. EIS results illustrated that charge transfer resistances increase but C_{dl} decrements with rising inhibitor dosage. FT-IR and AFM analyses proved that the particles of Polypodiophyta examined adsorb efficiently on the interface of C-steel. Achieved results through several measurements were equivalent.

References

1. Wan, S.; Wei, H.; Quan, R.; Luo, Z.; Wang, H.; Liao, B.; Guo, X. Soybean (2022) extract firstly used as a green corrosion inhibitor with high efficacy and yield for carbon steel in acidic medium. *Industrial Crops and Products*. **187**, , 115354, <https://doi.org/10.1016/j.indcrop.2022.115354>
2. Al-Akhras, N.; Mashaqbeh, Y. Potential (2021) use of eucalyptus leaves as green corrosion inhibitor of steel reinforcement. *Journal of Building Engineering*. **35**, , 101848.
3. Palanisamy, S.P.; Maheswaran, G.; Selvarani, A.G.; Kamal, C.; Venkatesh, G. Ricinus (2018) communis—A green extract for the improvement of anti-corrosion and mechanical properties of reinforcing steel in concrete in chloride media. *Journal of Building Engineering*. **19**, , 376-383.
4. Fouda, A. S.; Ismail, M. A.; Khaled, M. A.; El-Hossiany, A. A. (2022) Experimental and computational chemical studies on the corrosion inhibition of new pyrimidinone derivatives for copper in nitric acid. *Scientific Reports*. **12(1)**, , pp.1-19, <https://doi.org/10.1038/s41598-022-20306-4>
5. Bahrami, M. J.; S. M. Hosseini, A.; Pilvar, P. (2010) Experimental and theoretical investigation of organic compounds as inhibitors for mild steel corrosion in sulfuric acid medium, *Corros. Sci.* **52(9)**, 2010,27932803, <https://doi.org/10.1016/j.corsci.04.024>
6. Solomon, M. M.; Umoren, S. A.; Udosoro, I. I.; Udoh, A. P. (2010) Inhibitive and adsorption behaviour of carboxymethyl cellulose on mild steel corrosion in sulphuric acid solution. *Corros. Sci.* **52(4)**, ,13171325, <https://doi.org/10.1016/j.corsci.2009.11.041>
7. Liu F.G.; Du M.; Zhang J.; Qiu M. (2009) Electrochemical behavior of Q235 steel in saltwater saturated with carbon dioxide based on new imidazoline derivative inhibitor, *Corros. Sci.*, **51(1)**, 102.109. <https://doi.org/10.1016/j.corsci.2008.09.036>
8. Musa A.Y.; Kadhum A.A.H.; Mohamad A.B.; Takriff M.S. (2010) Experimental and theoretical study on the inhibition performance of triazole compounds for mild steel corrosion, *Corros. Sci.*, **52(10)**,33313340. <https://doi.org/10.1016/j.corsci.2010.06.002>
9. Acharya M.; Chouchan, J. S.; Dixit, A.; Gupta, D. k. Green(2013) Inhibitors for Prevention of Metal and Alloys. *Corrosion: An Overview. Chemistry and Materials Research*. **3**, , 101-111 <https://doi.org/10.1155/2012/380217>
10. Ayeni, F.A.; S.Alawode, D.; Joseph, P.; Sukop, V.; Olawuyi, T.E.; Alonge, O.O.; Alabi, O.; Oluwabunmi, F. I. Alo, (2014). Investigation of Sida acuta (wire weed) plant extract as corrosion inhibitor for aluminium-copper-magnesium alloy in acidic medium. *Journal of Minerals and Materials Characterization and Engineering*, **2(4)**, 2014, 201-219 <https://doi.org/10.4236/jmmce.24033>
11. Pandian, B. R.; Sethuraman, M. G. (2008) Natural products as corrosion inhibitor for metals in corrosive media—a review. *Material Letters*, **62(1)**, , 113-116, <https://doi.org/10.1016/j.matlet.2007.04.079>

12. Rani, B. E.; Basu, B. J. Green (2012) inhibitors for corrosion of metals: a review. *Chem. Sci. Rev. Lett.* **1(1)**, , 1-18, <https://doi.org/10.1155/2012/380217>
13. Kumar P.; Shetty A. N. Inhibition effect of adsorption layer of 1-phenyl-4-(4-nitrophenyl) thiosemicarbazide on the corrosion of 18 Ni 250-grade welded maraging steel in 1.0 M hydrochloric acid medium. *Res. Chem. Intermed.* **41(10)**, 201570957113. <https://doi.org/10.1007/s11164-014-1800-9>
14. Ouici H. B.; Benali O.; Guendouzi A. (2016) Experimental and quantum chemical studies on the corrosion inhibition effect of synthesized pyrazole derivatives on mild steel in hydrochloric acid. *Res. Chem. Intermed.* **42(9)**, , 7085-7109. <https://doi.org/10.1007/s11164-016-2520-0>
15. Makhlof, A. S. H.; Herrera V.; Muñoz, E. (2018) *Handbook of Materials Failure Analysis*, Elsevier, , 107–122.
16. Huang, L.; Chen, W.Q.; Wang, S. S, Zhao Q.; Li H.J., Wu Y.C. . (2022) Starch, cellulose and plant extracts as green inhibitors of metal corrosion: a review. *Environmental Chemistry Letters* Jun **21**:1-30.
17. Fouda, A.S.; Rashwan, S.; El-Hossiany, A.; El-Morsy, F. E. (2019), Corrosion Inhibition of Zinc in Hydrochloric Acid Solution using some organic compounds as Eco-friendly Inhibitors. *JCBPS.* **9(1)**, 001024, <https://doi.org/10.24214/jcbps.A.9.1.00124>
18. Fouda, A.S.; Abdel Azeem, M.; Mohamed, S.A., El-Hossiany, A.; El-Desouky, (2019) E. Corrosion Inhibition and Adsorption Behavior of Nerium Oleander Extract on CS in Hydrochloric Acid Solution. *Int. J. Electrochem. Sci.* **14**, , 3932–3948, <https://doi.org/10.20964/2019.04.44>
19. Salem, A. M.; Wahba, A.M.; El Hossiany, A., and Fouda, A.S. (2022) Experimental and computational chemical studies on the corrosion inhibitive properties of metamizole sodium pharmaceutical drug compound for CS in hydrochloric acid solutions. *Journal of the Indian Chemical Societ*, **99(12)**, 100778. <https://doi.org/10.1016/j.jics.2022.100778>
20. Boukhedena, W.; Deghboudj, S.; Benahmed, M.; Laouer H. (2022) Experimental Study and Modeling of the Corrosion Inhibition of Mild Steel in 1M Hcl with Novel Friendly Butanolic Extract of Ephedra Major. *Journal of the Mexican Chemical Society.* **66(2)**, ,118. <https://doi.org/10.29356/jmcs.v66i2.1630>
21. Kowsari, E.; Payami, M.; Amini, R.; (2014) Task-specific ionic liquid as a new green inhibitor of mild steel corrosion. *Appl. Surf. Sci.* **289**, , 478–486.
22. Solomon, M.M.; Umoren, S.A.; Israel, A.U.; (2015) Polypropylene glycol-silver nanoparticle composites: a novel anticorrosion material for aluminum in acid medium, *J. Mater. Eng.Perform.* **24**, , 4206–4218.
23. Sasikumar, Y.; Adekunle, A.S.; Olankanmi, L.O.; (2015) Experimental, quantum chemical and Monte Carlo simulation studies on the corrosion inhibition of some alkyl imidazolium ionic liquids containing tetrafluoroborate anion on mild steel in acidic medium. *J. Mol. Liq.* **211**, , 105–118.
24. Umoren, S.A.; Solomon, M.M.; Eduok, U.M (2014). Inhibition of mild steel corrosion in H₂SO₄ solution by coconut coir dust extract obtained from different solvent systems and synergistic effect of iodide ions: Ethanol and acetone extracts. *J. Environ. Chem. Eng.* **2**, , 1048–1060.
25. Fouda, A.S.; El-Gharkawy, E.S.; Ramadan, H.; El-Hossiany, A. Corrosion resistance of mild steel in hydrochloric acid solutions by clinopodium acinos as a green inhibitor. *Biointerface Res. Appl. Chem.* **11(2)**, 2021, 9786-9791.
26. Fouda, A. S.; Ahmed, R. E.; El-Hossiany, A. (2021) Chemical, electrochemical and quantum chemical studies for famotidine drug as a safe corrosion inhibitor for α-brass in HCl solution. *Protection of Metals and Physical Chemistry of Surfaces.* **57(2)**, , 398-411.
27. Hsissou, R.; Abbout, S.; Berisha, A.; Berradi, M.; Assouag, M.; Hajjaji, N.; Elharfi, A. ,(2019), Experimental, DFT

- and molecular dynamics simulation on the inhibition performance of the DGDCBA epoxy polymer against the corrosion of the E24 carbon steel in 1.0 M HCl solution. *Journal of Molecular Structure*. **1182**340351, <https://doi.org/10.1016/j.molstruc.2018.12.03>.
28. Vuong, B. X.; Huynh, T. L.; Tran, T. Q.; Vattikuti, S. P.; Manh, T. D.; Nguyen-Tri, P.; Nguyen, A. T.; Van Hien, P.; Dang, N. (2022) N. Corrosion inhibition of carbon steel in hydrochloric acid solution by self-formation of a *Malpighia glabra* leaf extract-based organic film. *Materials Today Communications*. **31**, , 103641, <https://doi.org/10.1016/j.mtcomm.2022.103641>
29. Manh, T.D.; Huynh, T.L.; Thi, B. V.; Lee, S.; Yi, J.; Nguyen Dang, N. (2022) Corrosion Inhibition of Mild Steel in Hydrochloric Acid Environments Containing *Sonneratia caseolaris* Leaf Extract. *ACS omega*. **7(10)**, ,887486. <https://doi.org/10.1021/acsomega.1c07237>