

STRUCTURAL BEHAVIOR OF SELF CURING REINFORCED CONCRETE FLAT SLABS WITH OPENINGS

N. Y. ELWakkad¹ KH. M. Heiza²

*1 Lecturer , Civil Engineering Department., Higher Institute of Engineering and Technology Kafr El-Sheikh.
2Professor, Civil Engineering Department, Faculty of Eng., Menoufiya University.*

Abstract:

Self curing concrete (SCC) is a new trend on construction industry. Flat plates are the most commonly used slab system today for multistory reinforced concrete hotels, hospitals, and apartment houses. In this investigation the focus will be on the effect of the reinforcement ratio and the effect of central square opening size on the behavior of self curing reinforced concrete flat slabs, This goal is achieved through the studying the structural behavior of ten RC tested slabs. The experimental program was carried out on ten reinforced concrete plate of (120 x 120 x 7) cm resting on four supports and subjected to concentrated load. The load was applied gradually in increments to record the first crack load, the failure load and the deflections at each load increment. Comparative study between the experimental results and previous research on high strength concrete slabs were performed. Self curing concrete flat slabs were recorded higher cracking loads than high strength concrete flat slabs. Deflections recorded from SCC were greater than deflection recorded from high strength concrete slabs.

Keywords: Self curing concrete, Fly Ash, Superplasticizer, Compressive strength, Flat slabs, Deflection, Reinforcement ratio, opening size

I. INTRODUCTION

Flat plates are reinforced concrete beamless solid slabs with or without drops, directly supported by columns with or without flared column heads. These slabs are mainly failed by shear [1-2]. Steel reinforcement is considered the main item in the concrete cost. The effect of reinforcement ratio on the flat self curing concrete [8,9,10,11,12,13,14] plates is researched. In many cases, Small openings are required in the slab to accommodate the electrical and mechanical services such as heating, plumbing and ventilating risers. The effect of the opening size on the behavior of the flat slabs is required to be found out [3,7]. To achieve these goals ten square flat plates (120 x 120 x 7) cm are prepared, casted and tested. Five slabs have different reinforcement ratio. The second five slabs have the same reinforcement ratio and have different central square side length starting from 10 to 40 cm.

Experimental Program

The aim of the experimental work carried out in this study is to investigate the following items:

1 -The effect of steel reinforcement ratio on the structural behavior of the self curing reinforced concrete flat slabs. For this purpose, five high strength concrete square slabs models (120 x 120 x 7) cm. having different steel reinforcement ratio as follows :

a) The first slab (SCR1) has a steel reinforcement ratio of ($\mu = 0.43 \%$).

b) The second slab (SCR2) has a steel reinforcement ratio of ($\mu = 0.57 \%$)

c) The third slab (SCR3) has a steel reinforcement ratio of ($\mu = 0.72 \%$).

d) The fourth slab (SCR4) has a steel reinforcement ratio of ($\mu = 0.87 \%$).

e) The fifth slab (SCR5) has a steel reinforcement ratio of ($\mu = 1.08 \%$).

All of these slabs have the same Polyethylene-glycol content (PEG =0.5%) by weight of the cement content.

2 -The effect of central square open size on the behavior of the self curing reinforced concrete flat slabs. For this purpose, four square slabs models (120 x 120 x 7) cm. having different central opening size as follows:

a) The first slab (SCO1) has no central opening.

b) The second slab (SCO2) has a central square opening size of 10 cm.

c) The third slab (SCO3) has a central square opening size of 20 cm.

d) The fourth slab (SCO4) has a central square opening size of 30 cm.

e) The fifth slab (SCO5) has a central square opening size of 40 cm.

All of these slabs have the same Polyethylene-glycol content (PEG =0.5%) by weight of the cement content and steel reinforcement ratio ($\mu = 0.57 \%$).

Table (1) Details of the Test Specimens

Series No.	Slab No.	Compressive Strength (MPa)	Slab Thickness (cm)	Reinforcement Ratio (μ) %	Opening Size (cm)
I	SCR1	50.55	7	0.43	-
	SCR2	50.55	7	0.57	-
	SCR3	50.55	7	0.72	-
	SCR4	50.55	7	0.87	-
	SCR5	50.55	7	1.08	-
II	SCO1	50.55	7	0.57	-
	SCO2	50.55	7	0.57	10x10
	SCO3	50.55	7	0.57	20x20
	SCO4	50.55	7	0.57	30x30
	SCO5	50.55	7	0.57	40x40

* SC –Self Curing, * R –Reinforcement, *O –Opening

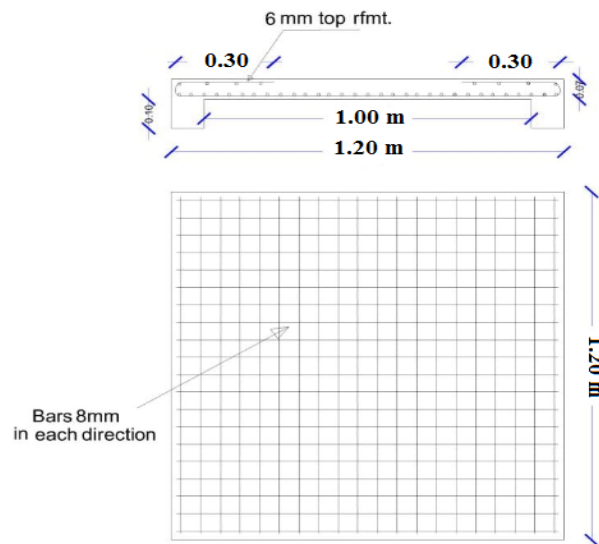

Fig.(3) Show dimensions of the typical tested slabs without opening and reinforcement details

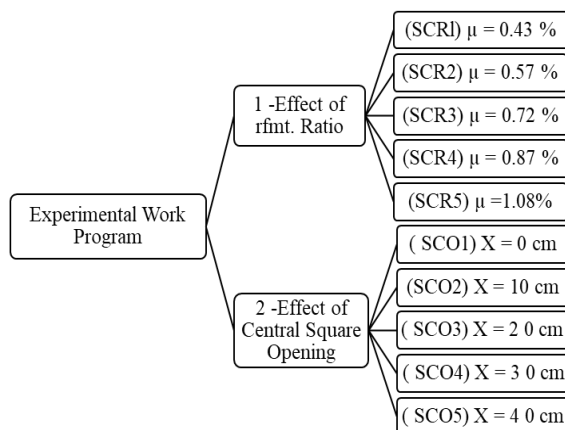

Fig.(1): Flow chart showing the experimental work program

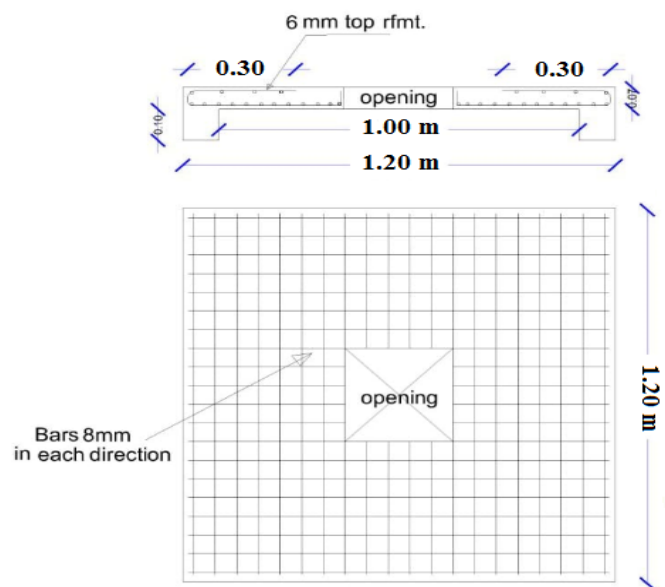

Fig. (4) Show dimensions of the typical tested slabs with opening and reinforcement details



Fig.(2) loading arrangement of SCC reinforcement slabs

II. MATERIAL USED IN REINFORCED CONCRETE SLABS

Cement: A locally produced ordinary Portland cement complied with E.S.S.373/91 requirements was used. [4]

Aggregate: The fine aggregate was siliceous natural sand. The coarse aggregate was crushed dolomite of maximum nominal size 14 mm was used.

Fly ash: The mineral admixture used in this experimental program is fly ash under a commercial name of Supper Pozz-5. [5]

Viscosity Enhancing Agent (VEA): The super-plasticizer used in this experimental program under a commercial name of Sika-Viscocrete 3425 from Sika Egypt [6].

Water: Ordinary potable water without acidity and alkanity available in the laboratory was used.

Polyethylene glycol-400: PEG-400 is added at rate of 0.5% of cement weight.[8]

Table (2) Self Curing Concrete Mix by weight

Mix proportions (Kg / m ³)						
Cement	Coarse Aggregate	Fine Aggregate	Fly Ash	Viscosity Enhancing Agent	Water	PEG%
366	1128	817	19	7.7	140	0.5

III. TESTING PROCEDURE

The RC plates were supported on four corner support. Each support was a reinforced concrete of (10x 10 x 10) cm. with four longitudinal corner bar of mild Ø steel (diameter = 10 mm.). Each plate model was loaded up to failure. Fig. (5) Shows the loading system:

1-For the first group (the effect of reinforcement ratio), we used one concentrated load at the center of the plate.

2-For the second group (the effect of the central square opening) system consists of two intersecting steel I-beams (S. I. B. NO. 10) which were used for distributing the concentrated load applied at the intersection of the two beams to four equal concentrated loads.

IV. MEASURING DEVICES

Deflectometers: Dial gauges of 0.01 mm accuracy and total capacity of 25mm, were used for deflection measurements at the bottom face of the RC slab.

Hydraulic Jack: Hydraulic jack of maximum capacity 100 kN and the load is applied at the center of the RC plate.

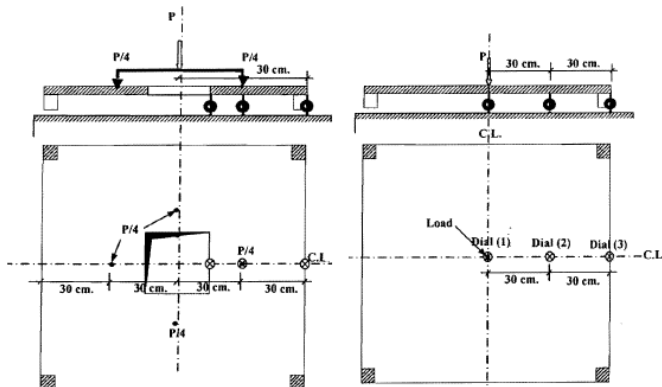

Fig. (5) Arrangement of Dials for Different Tested Plates [7]

IV. TEST RESULTS

Test results of the two groups are discussed from the view point of: deflection, cracking behavior, and ultimate load. The values of deflection, cracking load and ultimate load for tested slabs are listed in table (3).

Table (3) Experimental Test Results of SCC Slabs

Group No.	Slab Code	Rfimt μ%	First Crack Load (kN)	Deflection at First Crack (mm)		Ultimate Load (kN)	Deflection at Ultimate Load (mm)	
				At Point (1)	At Point (2)		At Point (1)	At Point (2)
Group (I)	SCR1	0.43	20	2.1	1.26	22	9.66	7.06
	SCR2	0.57	18	0.96	1.11	22	16.77	15.79
	SCR3	0.72	18	1.17	1.01	32	40.82	27.57
	SCR4	0.87	24	1.92	1.6	34	18.75	14.89
	SCR5	1.08	26	2.77	3.03	38	19.81	15.24
Group (II)	SCO1	0.57	24	1.13	0.9	30	15.17	13.11
	SCO2	0.57	24	1.09	0.96	30	14.87	13.31
	SCO3	0.57	20	2.02	1.87	22	14.62	12.58
	SCO4	0.57	18	7.09	5.79	24	23.58	19.19
	SCO5	0.57	18	1.95	2.14	24	18.7	18.5

Load -Deflection Characteristics

The load deflection curves were obtained using dial gauges of 10 mm with 0.01 mm accuracy. In all specimens the deflection values were recorded in three points laying along the center line of the RC plates. Figures (6) through (9) show the load deflection relationship for different plates of each group.

Figures (6), and (7) show the deflections of the SCC slabs reinforced with different reinforcement ratios. The deflection proportion inversely with reinforcement ratio. Slab SCR1 which have minimum reinforcement ratio has registered maximum deflection while slab SCR5 with maximum reinforcement ratio has registered minimum deflection.

For slabs with opening side length increase, the overall stiffness of the slab decrease, consequently the deflection increase, as Shown in figure (8).

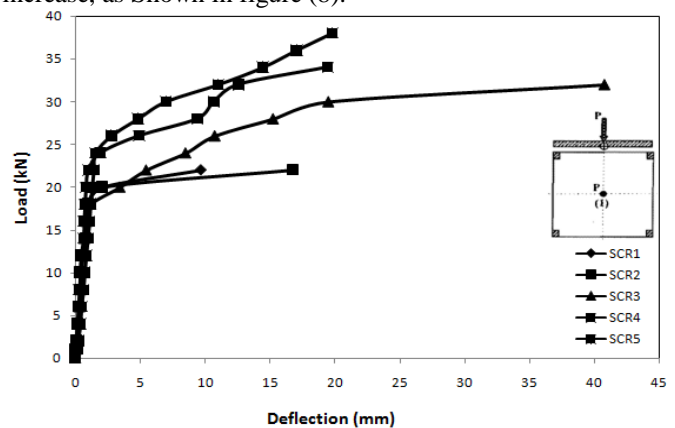

Fig. (6) Load -Deflection Comparison for RC Plates of Group (I) at Point (1)

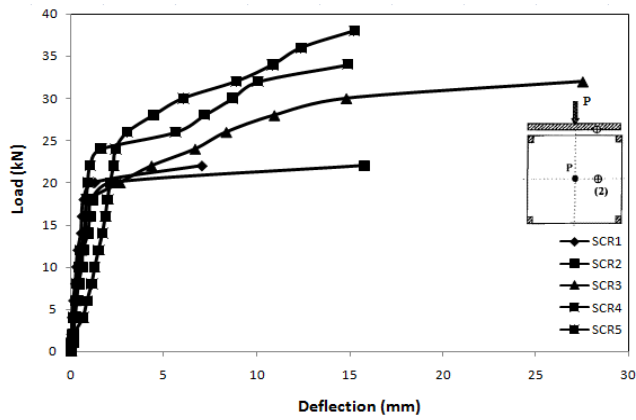

Fig. (7) Load -Deflection Comparison for RC Plates of Group (I) at Point (2)

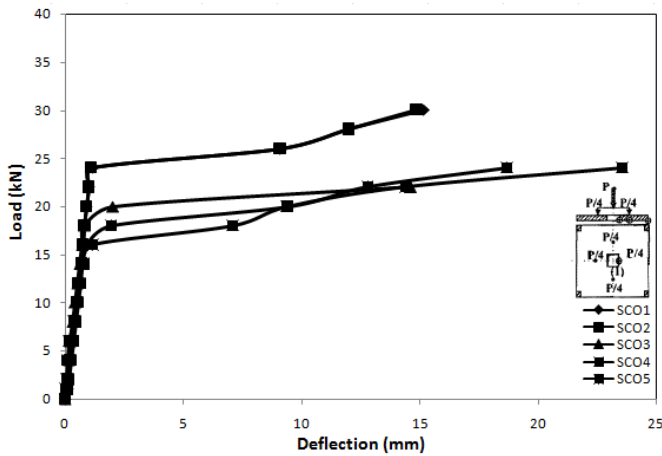

Fig. (8) Load -Deflection Comparison for RC Plates of Group (II) at Point (1)

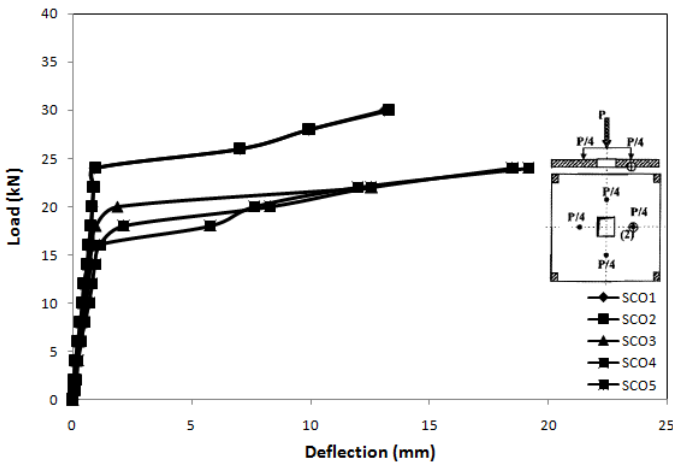

Fig. (9) Load -Deflection Comparison for RC Plates of Group (II) at Point (2)

Cracking behavior

First cracking load (P_{cr}) and Ultimate loads (P_{ult}) for all tested slabs are shown in figures (10) and (11). For group (I) slabs with different reinforcement ratio the cracking load is not consistent with the reinforcement ratio $\mu\%$. In case of SCR5 the cracking load was bigger than all the previous cases. It was expected that the cracking load is proportional to the reinforcement ratio.

For group (II) In general the results were consistent, as the opening side length increase, the cracking load decrease.

Ultimate Load

The values of ultimate load (P_{ult}) compared to the cracking load (P_{cr}) for all tested slabs are shown in figures (10) and (11). For group (I), the increase in reinforcement ratio is accompanied by increase in the ultimate load capacity as expected. RC Slabs with opening (group II), In general the results were consistent, as the opening side length increase, the ultimate load decrease.

side length increase, the ultimate load decrease.

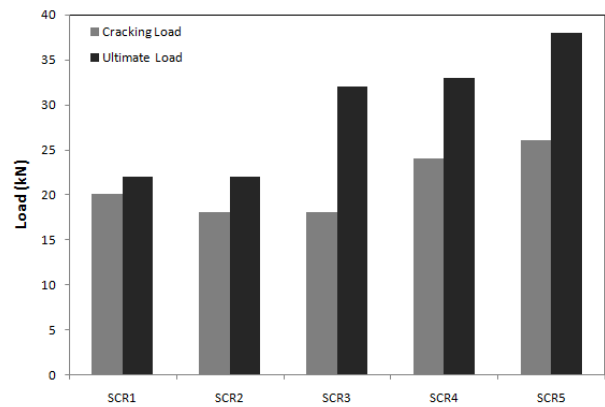

Fig. (10) Cracking and Ultimate Load for RC plates of Group (I) Effect of Reinforcement Ratio $\mu\%$

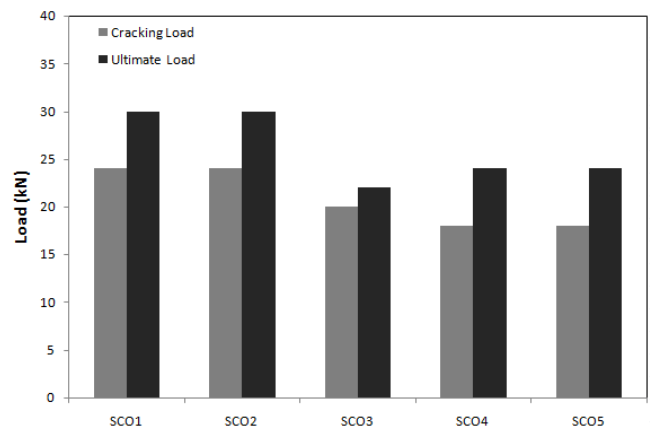

Fig. (11) Cracking and Ultimate Load for RC plates of Group (II) Effect of Opening Size

Mode of Failure

In general, all slabs failed under pure bending as shown in figures (12) & (13). Tests showed general behavior for all the slabs under flexural loading can be described as follows: at early stage of loading, the first cracks initiate at the center of bottom face, the load in this stage is known as first crack load. With increasing loads, cracks start to extend from the center toward the slab edges. At the same time the cracks increase in number and become wider. A complete failure occurred by increasing the load and all tested slabs were failed in flexure.

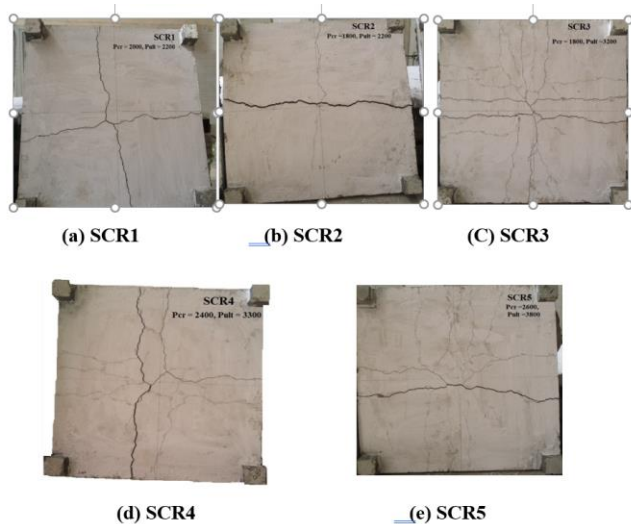

Figure (12) Mode of Failure for RSCC Group (I)

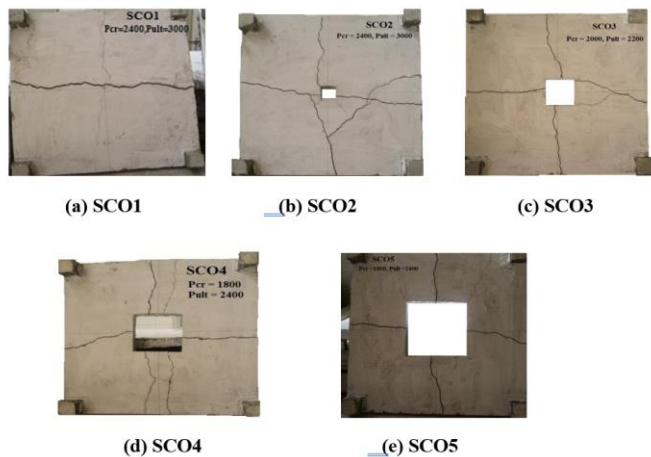

Figure (13) Mode of Failure for RSCC Group (II)

Comparison between high strength RC slabs [7] and self curing RC slabs:

The deflection of the tested slabs are inversely proportional to the characteristic strength of concrete where high strength concrete slabs which has a characteristic strength of 65 MPa

has recorded minimum deflection at all load stages. While self curing reinforced concrete slabs have showed larger deflections as shown in table (4).

The ultimate load capacity of high strength reinforced concrete slabs is greater than the ultimate load capacity of self curing reinforced concrete slabs. The ultimate load capacity of slabs is proportional to the characteristic strength of concrete as shown in figures (14) through (17).

Table (4): Comparison between high strength RC slabs [7] and self curing RC slabs results:

Type of Slabs	Concrete Strength MPa	Group No.	Slab Code	R _{fm} t μ %	First Crack Load (kN)	Deflection at First Crack (mm)		Ultimate Load (kN)	Deflection at Ultimate Load (mm)			
						At Point (1)	At Point (2)		At Point (1)	At Point (2)		
High Strength Reinforced Concrete Slabs	65	Group (II)	HSR1	0.43	14	1.6	1.02	28	6.1	4.57		
			HSR2	0.57	16	1.67	1.2	32	7.12	4.82		
			HSR3	0.72	16	1.24	0.99	32	5.54	4.2		
			HSR4	0.87	16	1.18	0.85	34	6.33	4.7		
			HSR5	1.08	20	1.88	1.3	34	5.02	4.21		
		Group (III)	HSO1	0.57	22	1.84	1.61	42	7.76	5.1		
			HSO2	0.57	22	1.79	1.67	42	7.21	5.21		
			HSO3	0.57	28	3.55	2.81	40	8.67	5.71		
			HSO4	0.57	28	4.32	3.88	40	8.33	6.98		
			HSO5	0.57	24	3.89	3.46	36	7.86	6.84		
		Self Curing Reinforced Concrete Slabs	50.5	Group (I)	SCR1	0.43	20	2.1	1.26	22	9.66	7.06
					SCR2	0.57	18	0.96	1.11	22	16.77	15.79
					SCR3	0.72	18	1.17	1.01	32	40.82	27.57
					SCR4	0.87	24	1.92	1.6	33	18.75	14.89
					SCR5	1.08	26	2.77	3.03	38	19.81	15.24
Group (II)	SCO1			0.57	24	1.13	0.9	30	15.17	13.11		
	SCO2			0.57	24	1.09	0.96	30	14.87	13.31		
	SCO3			0.57	20	2.02	1.87	22	14.62	12.58		
	SCO4			0.57	18	7.09	5.79	24	23.58	19.19		

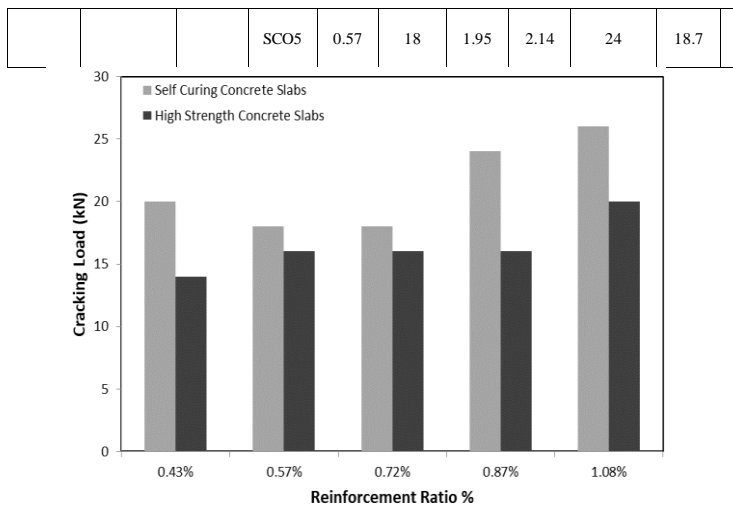

Fig.(14)Comparison between Self Curing Reinforced Concrete Slabs and High Strength Reinforced Concrete Slabs [7] at Cracking Load with Different Reinforcement Ratio $\mu\%$

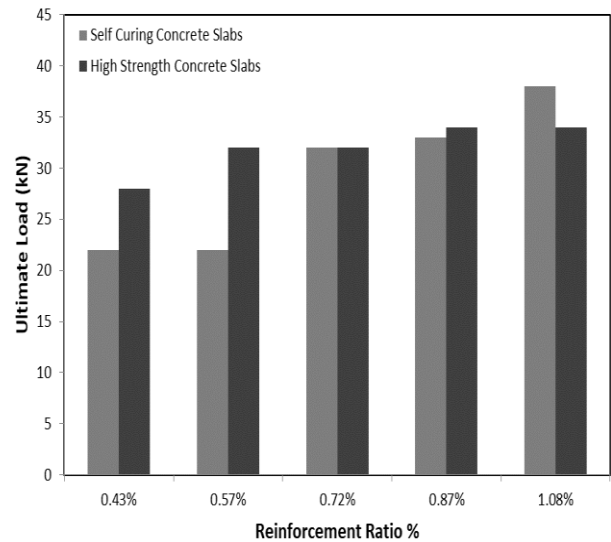

Fig.(16)Comparison between Self Curing Reinforced Concrete Slabs and High Strength Reinforced Concrete Slabs [7] at Ultimate Load with Different Reinforcement Ratio $\mu\%$

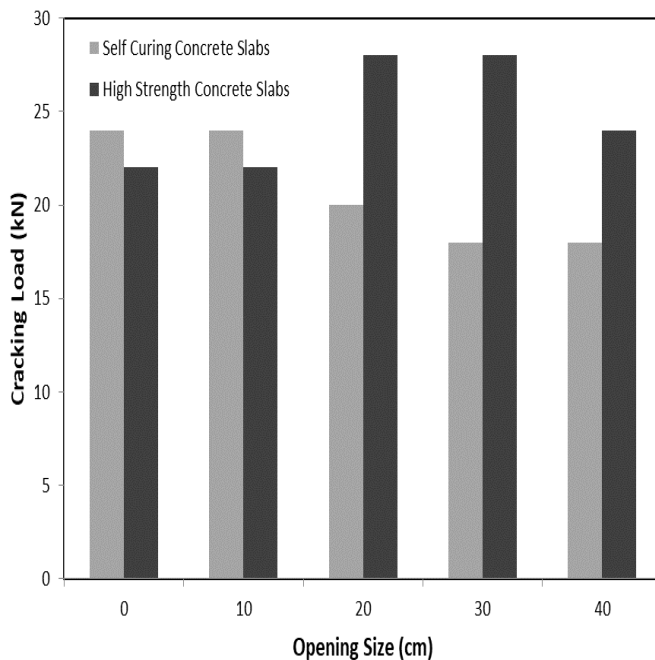

Fig.(15)Comparison between Self Curing Reinforced Concrete Slabs and High Strength Reinforced Concrete Slabs [7] at Cracking Load with Different Opening Size

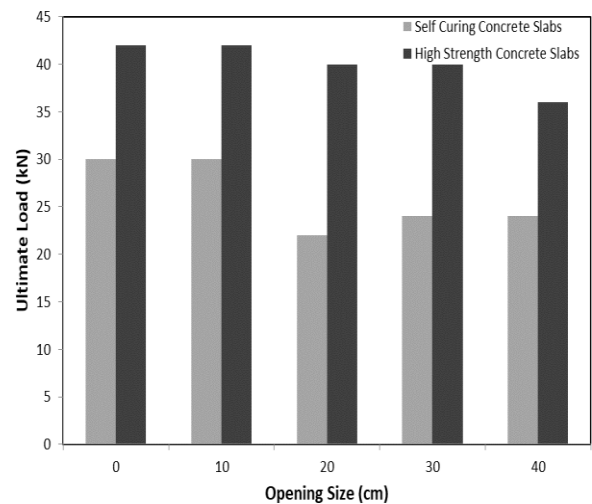

Fig.(17)Comparison between Self Curing Reinforced Concrete Slabs and High Strength Reinforced Concrete Slabs [7] at Ultimate Load with Different Opening Size

V. CONCLUSIONS

Experimental results showed that the deflection proportion inversely with reinforcement ratio.

2- It was expected that the cracking load is proportional to the reinforcement ratio.

3-The ultimate load of self curing reinforced concrete slabs increase by increase in reinforcement ratio.

4- The ultimate load of self curing reinforced concrete slabs did not change with the presence of square central opening with the side length equal 10 % of the slab side length.

5- The ultimate load decreased approximately by 26% for opening with the side length equal 20 % of the slab side length.

6- The ultimate load decreased by about 20% for opening with the side length equal 30 % and 40% of the slab side length.

- 7- The ultimate load capacity of slabs is proportional to the characteristic strength of concrete.
- 8- The ultimate load increase in reinforcement ratio of high strength reinforced concrete slabs by 3% up to 45% more than self curing reinforced concrete slabs.
- 9- The ultimate load increase in reinforcement ratio of high strength reinforced concrete slabs by 40% up to 66% more than self curing reinforced concrete slabs.

References

- [1] "Building code requirements for reinforced concrete (318), "American concrete institute, Detroit, 1995.
- [2] Egyptian code of practice, "Design and construction for reinforced concrete structures", 1997.
- [3] Boon,k.H, Diah,A., and Loon,L.Y.,” Flexural Behaviour of Reinforced Concrete Slab with Opening”, Malaysian Technical Universities Conference on Engineering and Technology, June 20-22, 2009.
- [4] ECCS 373/1991 Specification for Ordinary Portland Cement Egyptian Standards.
- [5] South Africa Company For Chemical Admixtures:Web Site: www. Ashresoures2018.
- [6] Sika Egypt for Construction Chemicals S.A.E.International.
- [7] Heiza, KH., Farah, N., Melaka, N.N. and Tayel, M.A.,”Experimental Study Of High Strength Concrete Slabs”, ERJ Journal, Vol.28 No.1, 2005.
- [8] Heiza, KH., and Elwakkad, N.,”Mechanical Properties Of Self Curing Concrete Incorporating PEG400”,under publishing.
- [9] Siddiqui Mohammed Junaid, Bhadki Safwan, Bodale Ahamad, Sayyad Kaleem and Ulde Nuh,” An Experimental Investigation on Internally Cured Concrete”, International Journal on Recent and Innovation Trends in Computing and Communication, April 2016, Volume 4, Issue 4, pp.241-244.
- [10] A.S.Thakare, S.P.Pethe, A.A.Sarode,and R.S.Shah,” Comparison Between Self Cured Concrete and Conventionally Cured Concrete”, International Conference on Science and Technology for Sustainable Development (ICSTSD)- 2016, pp. 102-106.
- [11] Dadaji B. Jadhav and Ranjana Ghate,” A Study on Self-Curing and Self-Compacting Concrete Using Polyethylene Glycol”, International Research Journal of Engineering and Technology (IRJET), Volume: 04 Issue: 02, Feb -2017, pp. 1014-1019.
- [12] Banothu Anusha,” Study And Analysis of Self-Curing Concrete Using Polyethylene Glycol”, International Journal of Engineering Research-Online, Vol.4., Issue.1., (Jan-Feb) 2016, pp. 662-666.
- [13] Heiza, KH., et al,”Light Weight Self Compacting Concrete with Light Expanded Clay Aggregate”, Matee Web Conferences 162, 02031, May (2018).
- [14] Elwakkad, N. and Heiza, KH.,”State of the Art Review on – Self Curing Concrete”,under publishing.