

## Solar air conditioning systems

### أنظمة التكييف الشمسية

By

Dr. MOHAMMED AWWAD ALI AL-DABBAS

Assistance professor, Mechanical Engineering department, Mutah University, Karak, Jordan.

[madabbas@mutah.edu.jo](mailto:madabbas@mutah.edu.jo), [madabbas@yahoo.com](mailto:madabbas@yahoo.com)

#### الملخص

تم في هذا البحث تصميم وبناء مكيف شمسي يعمل باستخدام الخلايا الشمسية، حيث تم تشغيل هذا المكيف الشمسي بنجاح لفترات زمنية متواصلة (٢٤ ساعة) ولعدة أيام دون حدوث مشاكل فنية. وتعتمد فكرة عمل هذا المكيف الشمسي على تحويل الحرارة المكتسبة من أشعة الشمس إلى طاقة كهربائية باستخدام الخلايا الشمسية، والتي تقوم بتوليد تيار كهربائي مباشر، وعليه يقوم المحول بتحويل هذا التيار الكهربائي المباشر إلى تيار متردد من خلال زيادة لفولطية هذا التيار للوصول إلى الفولطية اللازمة لتشغيل النظام.

أثبتت الحسابات النظرية أن معامل الأداء لهذا المكيف الشمسي يساوي ٤,٢، في حين أثبتت النتائج العملية أن معامل الأداء حوالي ٥,١ وهي نتيجة جيدة.

## Abstract

The solar photovoltaic air conditioning system was built successfully with all of its part which includes the inverter which converts the current from direct current into alternative current to pass it then to the transformer which increases the voltage on the expense of the current to reach the required voltage and definitely the power to operate the system.

The performance of any mechanical system must be evaluated to make sure that the system works successfully, in air conditioning design the COP (Coefficient Of Performance) must be calculated and here we got COP for the system about 5.1 and comparing it with another works, the computer program gave a result for the COP equals to 4.2 which is nearly the same taking in consideration that our systems data were taken for a period of 24 hours and the average of them were taken as the final results.[1-2]

## Photovoltaic (PV)-air-conditioning

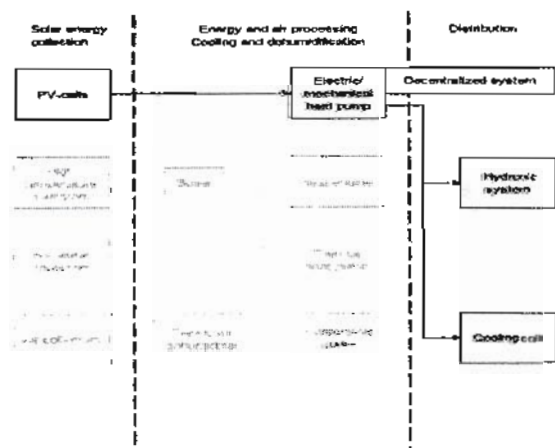

Fig. 1: Schematic Photovoltaic-air-conditioning systems

A DC-to-AC or AC-to-DC converter might be needed, either to convert DC current from the PV-cells to AC for driving the heat pump, or if a DC-powered heat pump is used, to convert AC grid electricity to DC.

Some advantages of this architecture are that off the shelf products can be used, even for very small systems.  $COP_{sol}$  can be rather high (0.25-0.56) and since they often use high COP vapor compression heat pumps their  $COP_{aux}$  is equal to the COP of a conventional vapor compression system. Excess power can easily be used in the internal grid or sold to the public grid. Decentralized systems can be used. An already existing conventional system, even if decentralized, can easily be converted to a solar-assisted system by simply adding PV-cells to the internal grid.

The great disadvantage of PV-air-conditioning is the high cost of the PV-cells. At current prices this system cannot economically compete with heat driven systems other than for small-scale systems. For small systems they are almost equally expensive.[3-4]

The most attractive, where a public grid exists, seems to be to build the system as a solar-assisted system, especially since it would be very expensive to cover the whole load with PV-cells because of their high cost. If the system would be built as a solar autonomous system some kind of storage, either batteries or cold storage, might be needed. Because a vapor compression system can produce temperatures below 0°C with rather good efficiency an ice-storage could be considered.

## Experimental work And Design

The A/C unit consists of four basic parts these are; a compressor, an expansion valve, an evaporator and a condenser, we also showed for every part of them; how it works and what the phase of the working fluid through every part is. However, in designing this unit the designer must know what is the usage of his work, for example the size of the evaporator depends on the volume of the room and the power needed for the compressor depends on the size of the evaporator.

Our system contains also an electrical part; it consists basically of a photovoltaic cell, an inverter, a capacitor, a transformer and a power storage unit (battery).

Here we designed this unit according to many parameters; air conditioner is enough to maintain a small room of  $12 \text{ m}^3$  volume under a temperature range of  $22\text{-}25 \text{ }^\circ\text{C}$  (according to the outside temperature).

### Mathematical model

As we mentioned that our work is not only an air conditioning unit, it is also a zero operation cost unit, we used the solar energy to operate this system and the solar energy is free specially in the days which the air conditioner must still working to stay under a comfortable temperature.

The main part in the A/C which needs high power to be operated is the compressor; it consumes about 90% of the total electrical power needed for the operation of the system, so we used the photovoltaic cells to operate the compressor and the other electrical parts of the system to support its operation, when we designed it we decided that the minimum capacity of the compressor that would produce the maximum power should be one fifth horse power, this amount of power could be produced from a photovoltaic cell but we still need to calculate the area of the PV cell that will produce this power, here is the calculations:[5-15]

### Components background [12-15]

#### *Mechanical parts.*

In this section we will explain each mechanical part and the principle of it and more information which help the reader to understand the system taking in consideration that the reader doesn't have to be a mechanical engineer.

**1. Compressor:** Leaving the evaporator the refrigerant is a gas at a low temperature and low pressure. In order to be able to use it again to achieve refrigerating effect continuously, it must be brought back to liquid at a high pressure. The first step in this process is to increase the pressure of the refrigerant gas by using a compressor. Compressing the gas also results in increasing its temperature.

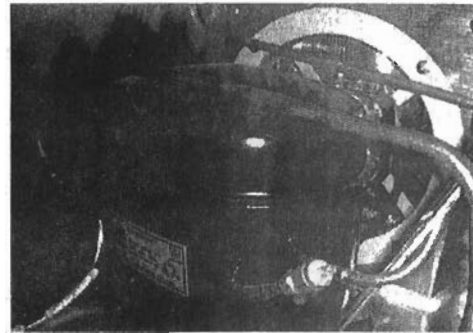

Fig1: The compressor used in the system

**2. Condenser:** The condenser is also a heat exchanger which used to liquidize the working fluid coming from the compressor, through the condenser the refrigerant goes from hot high pressure mixture to hot high pressure liquid by a condensation process happens by the rejection of the latent heat from the refrigerant to the outside atmosphere and then it is being sent to the expansion valve.

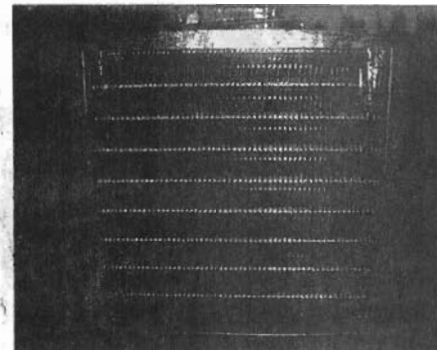

Fig2: The condenser used in the system

Heat gain to the air that goes through the condenser coils will be explained here;

The heat gain to the air equals:

$$Q_{air} = m_{air} * C_{p_{air}} * (T_{in} - T_{out})$$

Where;  $Q_{air}$  is the heat gain to the air,  $M_{air}$  is the flow rate of the exit air from the condenser fan,  $CP_{air}$  is the specific heat of the air at a constant pressure,  $(T_{in} - T_{out})$  is the temperature difference between the inlet and the exit air through the condenser. [11]

$$Q_{r123} = m_{R134a} * C_{F_{R134a}} * (T_{in} - T_{out})$$



Where;  $Q_{R134a}$  is the heat removed from the working fluid (R134a),  $M_{R134a}$  is the flow rate of the working fluid through the condenser coils,  $CP_{R134a}$  is the specific heat of the refrigerant at a constant pressure,  $(T_{in} - T_{out})$  is the temperature difference between the inlet and the exit of the condenser.

**3. Evaporator:** If you set in front of an air conditioner you will feel the cool air touching your skin; this cool air comes from the evaporator which absorbs the heat from room's air and drops its temperature. The evaporator is a heat exchanging coil which the refrigerant flows through in a mixture phase of gas and liquid with a temperature range of (-8 to -10), with a simple fan behind the evaporator we can exchange heat between the cool coils and hot room air to decrease its temperature, after the evaporator the mixture become totally vaporized.



Fig3: The evaporator used in the system.

Heat removed from the air that goes through the evaporator equals the heat gain to the refrigerant.

The heat removed from the air equals:

$$Q_{air} = m_{air} * C_{p_{air}} * (T_{in} - T_{out})$$

Where;  $Q_{air}$  is the heat removed from the air,  $m_{air}$  is the flow rate of the exit air from the evaporator,  $CP_{air}$  is the specific heat of the air at constant pressure,  $T_{in} - T_{out}$  is the temperature difference between the inlet and the exit air through the evaporator.

$$Q_{r123} = m_{R134a} * C_{p_{R134a}} * (T_{in} - T_{out})$$

Where;  $Q_{R134a}$  is the heat gain to the working fluid (R134a),  $M_{R134a}$  is the flow rate of the working fluid through the evaporator,  $cp_{R134a}$  is the specific heat of the refrigerant at constant pressure,  $T_{in} - T_{out}$  is the temperature difference between the inlet and the exit of the evaporator.

**Expansion valve:** After the refrigerant being compressed by the compressor its phase is changed into the liquid state at a relatively high pressure and high temperature then it flows through a restriction, called the flow control device or expansion device. The refrigerant loses pressure going through the restriction, the pressure after the expansion device is so low that a small portion of the refrigerant vaporizes into a gas but in order to vaporize, it must gain heat, thus cooling the mixture and resulting in a low temperature and that is the goal of the refrigeration process.

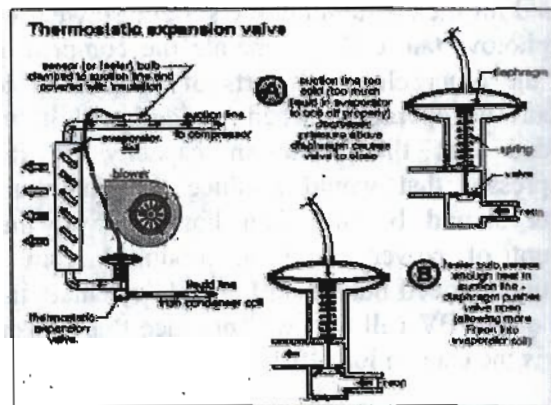

Fig4: Typical expansion valve.

**4. The filter:** It is an important part of any refrigeration unit which has a small parts of silica gel, the silica gel is a desiccant used to absorb the humid particles and impurities from the working fluid and it also supports the condenser to completely liquidize the refrigerant.



Fig5: The filter used in the system.

**Electrical part:**

The electrical part is very important to complete our work, so the explanation of the electrical devices we used and the characteristic of each one are shown here.

**1. Photovoltaic analysis:[2]**

We explained in a previous chapter the photovoltaic cells and we showed how it works and its components, here we will explain the characteristics of the PV cells we used in this system.

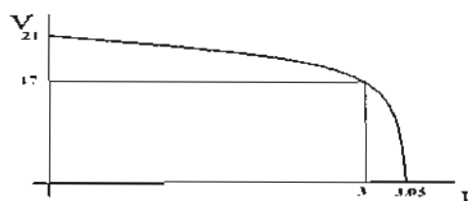

Fig 6: Photovoltaic cell characteristic.

Figure 6 shows the characteristic of a cell, it produces 21 V in short circuit and 17 V in full load contact and it also shows corresponding current for each voltage.

The straight line shows that the suitable is that which the voltage been 17 V at current 3A.

These data here are for one module, we used in our system 8 modules each 4 modules were connected in one array which have an area of 1 square meter. In one array -as we said- every module produces 17 V and 3A, so if we connected the modules in one array together in parallel form we will produce 12A and 17V and if we connected them in series form we will produce 68V and only 3A, but these data is not suitable for our system because the characteristic of the other components do not accept these data, so in each array we have connected every two modules in series to produce 34V and 3A and finally these modules will be connected in parallel to have 34V and 6A. Figure 11 shows the connection of the modules in one array.

**2. Inverter analysis:**

The basic function of a solar powered inverter is to convert the direct current into alternative current. Solar panels generate "direct current". But the electric motor inside the compressor runs on alternative current, current flows from a battery or solar cell on one direction, but an alternative current stream reverses direction 50 times each second, then we get the alternative current we need.

**3. Transformer analysis:** Electrical transformers used to transform voltage from a lower voltage to a higher voltage or vice versa. The principle of magnetic induction between coils makes it possible.

A transformer basically consists of a ferromagnetic core and two coils called "windings".

**System block diagram:**

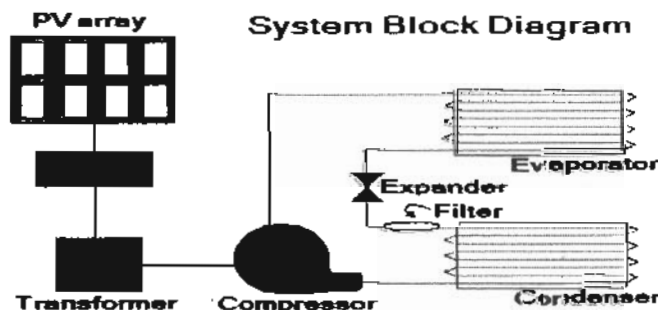

Fig 8: System block diagram

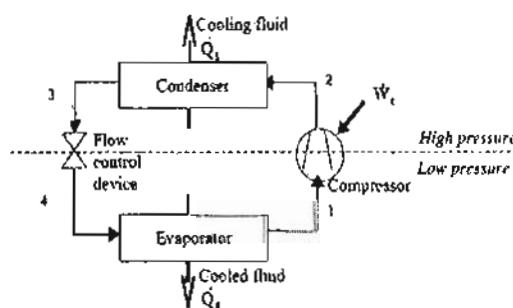

Fig 9: Vapor compression cycle [2]

**Refrigeration calculations**

Calculations of refrigeration cycle

$$Q_{evap} = Q_{cap} = M(h_1 - h_4)$$

Where  $Q_{evap}$  is heat loss from the evaporator,  $Q_{cap}$  is the refrigeration capacity,  $M$  is the mass flow rate,  $h_1$  is the enthalpy of the gas exited from the evaporator and  $h_4$  is the enthalpy of the refrigeration(liquid) entered to the evaporator

$$Q_{cond} = M(h_2 - h_3)$$

Where  $Q_{cond}$  is the heat rejected from the condenser,  $h_2$  is the enthalpy of gas exited from the compressor and  $h_3$  is the enthalpy of liquid exited from the condenser.

$$W_{com} = M(h_2 - h_1)$$

$W$  is the specific work of the compressor.

Power of compressor = specific work of compressor \*  $M$ .

Sample of calculation:

Temperature of refrigerant in the condenser is  $35^{\circ}\text{C}$  and the temp of refrigerant the in evaporator is  $-10^{\circ}\text{C}$ .

$$T_{cond} = 35^{\circ}\text{C} \quad T_{evap} = -10^{\circ}\text{C}$$

And from thermodynamics tables,

At  $T_1 = -10^{\circ}\text{C}$  the enthalpy at this point  $h_1 = h_g = 392.28 \text{ KJ/Kg}$

At  $T_3 = 35^{\circ}\text{C}$  the enthalpy at this point  $h_3 = h_f = 249.1 \text{ KJ/KG}$

And from fig 10a  $h_3 = h_4$

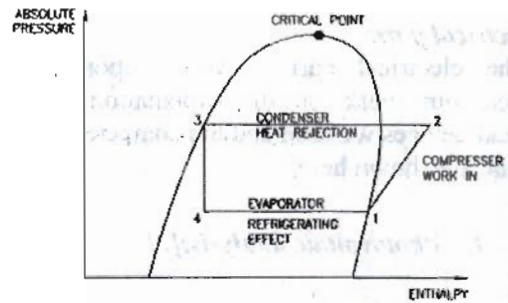

Fig 10a: P-h diagram for a refrigeration cycle

The process between position 1 & 2 is isentropic process (constant s) as we see in figure 10b.

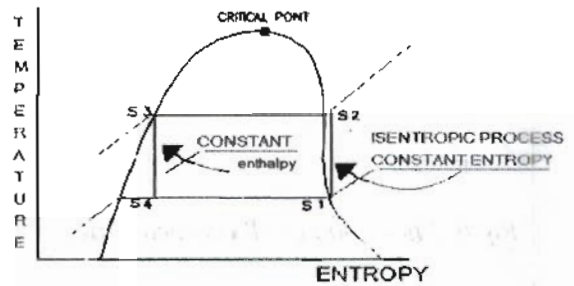

Fig 10b: T-S diagram for a refrigeration cycle

$S_1 = S_2 = 1.7319$  From tables of thermo dynamic (super heated) and using interpolation method

$$h_2 = 420.6546 \frac{\text{KJ}}{\text{Kg}}$$

$$W_{comp} = h_2 - h_1 = 420.6546 - 392.28$$

$$= 28.374 \frac{\text{KJ}}{\text{Kg}}$$

$$\text{Refrigeration effect} = h_1 - h_4$$

$$\text{Refrigeration effect} = 392.28 - 249.1$$

$$= 143.18 \frac{\text{KJ}}{\text{Kg}}$$

$$\text{Compressor Power} = (1/5) \text{ hp}$$

$$\text{And 1 hours power} = 0.7457$$



$$(1/5) \text{ hp} = 0.14914 \text{ kw}$$

$$\text{Compressor Power} = \text{Compressor Work} * M.$$

$$M = \frac{0.14914}{28.374} = 0.00525 \frac{\text{Kg}}{\text{s}}$$

$$Q_{\text{evap}} = Q_{\text{cap}} = M (h_1 - h_4)$$

$$= 0.00525 (392.28 - 249.1) = 0.75169 \text{ KW.}$$

Knowing that 1 ton refrigeration = 3.517 KW

$$1 \text{ HP} = 0.75169 / 3.517 = 0.214 \text{ ton refrigeration}$$

$$\text{Coefficient of performance} = \frac{\text{Refrigeration effect}}{\text{Compressor work}}$$

$$\text{C.O.P} = \frac{h_1 - h_4}{h_2 - h_1} = \frac{392.28 - 249.1}{420.654 - 392.28}$$

$$= 5.0461$$

That means that the quantity of refrigeration effect equals 5.0461 times of the compressor work.

**Design calculations:**

*electric parts analysis:*

*1. photovoltaic calculations:*

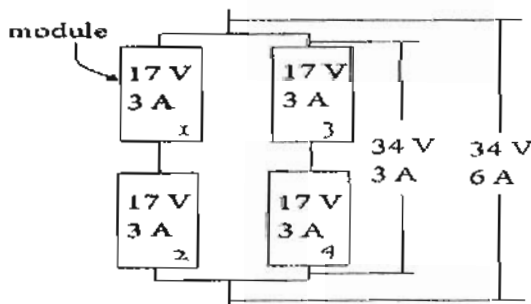

Fig 11: The arrangement of one module.

We have two arrays, so if we connected these two arrays in parallel form the overall output from the PV cells will be 68 V and 6 A.

The arrangement shown in fig11 could be written mathematically as the following;

$$V_{\text{array}} = V_1 + V_2 \text{ or } V_3 + V_4 \dots \text{ the summation of the series module voltages}$$

$$= 17 + 17 = 34 \text{ V}$$

$$I_{\text{array}} = I_1 + I_2 \dots \text{ the summation of the parallel module amperes}$$

$$= 3 + 3 = 6 \text{ A}$$

And,

$$V_{\text{total}} = 2 * V_{\text{array}} = 2 * 34 = 68 \text{ V,}$$

Because we connected them in parallel.

And,

$$I_{\text{total}} = I_{\text{array}} = 6 \text{ A, because we connected them in parallel.}$$

Power produced from these two arrays:

$$P_{\text{array}} = I_{\text{array}} * V_{\text{array}} = 6 * 34 = 204 \text{ W}$$

$$P_{\text{total}} = 2 * P_{\text{array}} = 2 * 204 = 408 \text{ W}$$

But here we had a problem which the current produced from the PV is a direct current (DC) and when we searched for a compressor works on a direct current we found the characteristics of them do not mach what we want to operate, now we have either to find a suitable DC compressor or to convert this current into alternative current (AC).

To convert the direct current into alternative current we must use a device which called inverter to make the current usable in the system.

*2. Inverter analysis: [9]*

$$\text{Efficiency of the inverter: } \eta_{\text{inv}} = 98 \%$$

$$\text{Final power} = \text{power}_{\text{pv}} * \eta_{\text{inv}}$$

$$= 408 * 98\% = 400 \text{ W}$$

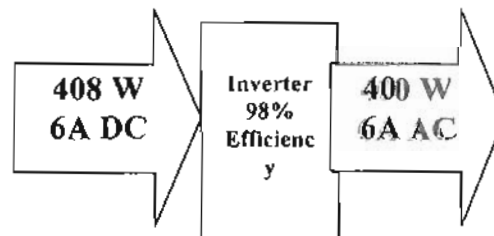

**3. Transformer analysis:**

When power goes through the primary winding then it will generate in the secondary winding the same power but in different values of voltage and current according to the following equations:

$$V_1 * N_1 = V_2 * N_2$$

Or  $V_2 = V_1 * (N_1 / N_2)$

$(N_1/N_2)$  is the factor which converts the voltage produced from the photovoltaic to 220 V but the current will become low. [9]

Here we designed the transformer to have  $(N_1 / N_2)$  equals to 3.2353, by making the primary and the secondary winding 220 and 68 respectively.

$$V_2 = 68 * 3.2353 = 220 \text{ V}$$

And,

$$P_{in} = P_{out}$$

$$I_{inv} * (I * V)_{in} = (I * V)_{out} ; 0.98 * 6 * 68 = I_{out} * 220$$

$$I_{out} = 1.8182 , \text{ for ideal transformer.}$$

but in this case the efficiency of the transformer could be calculated by:

$$\eta_{transformer} = P_{out} / P_{in}$$

And when we passed a power of 400 watts through this transformer we had 320 watts as an output.

$$\eta_{transformer} = 320 / 400 = 80\%$$

we can now find the current output for the transformer,

$$I_{out} = \eta_{transformer} * I_{ideal} = 0.8 * 1.8182 = 1.4545 \text{ A}$$

As Power is a constant, the current in the secondary winding will be less.

Our system needs power to be operated and this power is divided by each electrical device and it is explained as following:

- The compressor needs 149 W
- Evaporator blower needs 85 W
- Condenser fan needs 35 W
- Total power is equal to  $149 + 85 + 35 = 269 \text{ W}$

And we have 320 watts so the electrical power can operate the air conditioner and there is an excess power could be used in other mechanical system to support our air conditioner like flow leader to move the air all around the room.



Fig 12: The transformer.

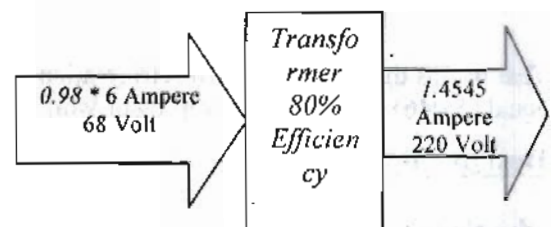

**Mechanical parts analysis:  
Condenser design:**

To design the condenser we have to follow these steps [1]

1. Calculate the heat rejection ratio (h.r.r).

$$h.r.r = \frac{Q_{condenser}}{Q_{evaporator}}$$

h.r.r is the heat rejection ratio.

$$h.r.r = 1 + \frac{1}{c.o.p}$$

c.o.p is the coefficient of performance.

$$h.r.r = 1 + \frac{1}{5.04}$$



$$h.r.r = 1.1984.$$

2. calculate heat transferred from the condenser.

$$Q_{cond} = h.r.r * Q_{evaporator}.$$

$$Q_{COND} = 1.1984 * 0.75169$$

$$Q_{COND} = 0.9008 \text{ KW}$$

3. Calculate the overall heat transfer coefficient of the condenser

$$U = \frac{1}{h_{ref}} + \frac{X_{Ao}}{KA_m} + \frac{1}{h_{air}} * \frac{D_m}{D_{out}}$$

$$H_{REF} = 0.725 * \left( \frac{g\rho^2 h f g k^3}{\mu \Delta T_{md}} \right)^{\frac{1}{4}}$$

$$= \frac{1}{v f}$$

$$r = 0.8571 \text{ at } 35^\circ \text{C.}$$

$$= \frac{1}{0.8571}$$

$$= 1.1668 \text{ Kg/L} = 1168 \text{ Kg/m}^3$$

is the density of refrigerant fluid (r-134a).

$h_g = 168420 \text{ J/Kg}$  at  $35^\circ \text{C}$  from thermo dynamic tables .

$K = 0.0741$  is the conductivity for the gas r-134a from heat transfer tables.

$= 1.7535 \times 10^{-4}$  is the viscosity for the gas r-134a from heat transfer tables .

$\Delta T = 5$  is the temperature difference between the vapor and the tube.

$N = 3.23$  average number of tube .

$D$  = the outer diameter .

$$H_{REF} = 0.725 \left( \frac{9.81 * 1166.8 * 168420 * (0.0741)^3}{1.7535 * 10^{-4} * 3.23 * 0.01} \right)^{\frac{1}{4}}$$

$$= 2584.6 \frac{w}{m^2.k}$$

The conductivity of copper is  $390 \text{ w/m.k}$

$$\text{The resistance of the tube} = \frac{X}{D} \left( \frac{D_{out}}{2.(D_{in} + D_{out})} \right),$$

$x$  is the thickness of the tube

$$= \frac{(0.01 - 0.008)/2}{390} \frac{10}{(8+10)/2}$$

$$= 0.000002849 \frac{m^2.k}{w}$$

To calculate the air side heat transfer coefficient  $h_{air}$ , we use the air properties at  $T = 24^\circ \text{C}$ .

$$h_{air} = 0.023 \frac{k}{d_{inner}} \left( \frac{v D \rho_{air}}{\mu} \right)^{0.8} \left( \frac{C_p \cdot \mu}{k} \right)^{0.4}$$

$$h_{air} = 0.023 \frac{1.578 \times 10^{-5}}{0.008}$$

$$\left( \frac{4(0.008)(1.12)}{1.857 \times 10^{-5}} \right)^{0.8}$$

$$\left( \frac{1004(1.857 \times 10^{-5})}{1.578 \times 10^{-5}} \right)^{0.4}$$

$$h_{air} = 0.3551 \text{ w/m}^2 \text{ k}$$

Where  $k$  is the conductivity of air,  $V$  is the air velocity,  $D$  is the inner diameter of the pipe,  $\mu$  is the viscosity of air, and  $C_p$  specific heat at constant pressure.

The overall heat transfer coefficient is.

$$U_o = (1/2584.6) + (0.000002849)$$

$$+ (1/0.3551) * (0.010/0.008)$$

$$U_o = 390 \text{ w/m}^2 \text{ k}$$

4. Calculate the Area of the condenser [12]

$$Q_{cond} = U_o A_{cond} T_{lmd}$$

$$T_{lmd} = \frac{((35 - 21.5) - (35 - 26.5))}{\ln \frac{35 - 21.5}{35 - 26.5}} = 10.1^\circ \text{C.}$$

$$Q_{cond} = 390 * A * 10.1$$

$$A_{cond} = \frac{900.8}{390 * 10.1} = 0.2286 \text{ m}^2$$

Length of the tube.

$$L_{tube} = \frac{0.2286}{16 \text{ tube} * (0.010 \times \pi)} = 0.4578 \text{ m.}$$

**Payback period**

Every useful work must return to his owner his money back in a certain time; so in our case we will get our money back by the reduction to the electric power consumptions expenses.[16-18].

A successful work should provide a Return On Investment (ROI) in a time frame that gives the manufacturer a decent revenue. This work is based on achieving this goal by the reduction of the electric bill.

Here we show the average home used energy, as we see from figure 13, the amount of energy used for cooling is about 12 % of our total electric consumption.

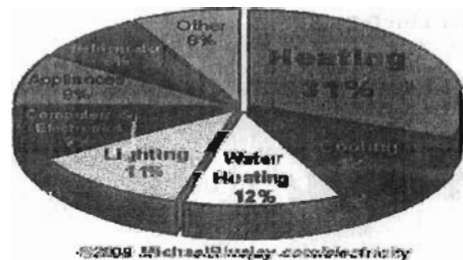

Figure 13 : Average home used energy

If we assume that we have an air conditioning unit that has a power of 1440 watts (homogenous window unit AC) and it is operated for a certain period during the day, it will consume an amount of electricity proportional with the duration of operation.

In Jordan the average cost of electricity is 0.07 JD for each kilowatt hour, and the payback period could be calculated from the following equation.

$$A = \frac{T}{C * D * N * P * S}$$

Where: A is the payback period in years, T is the total coast of our work, C is the cost of kilowatt hours in JD, D is the duration in hours per day, N is the number of days in a month, P is the power of the electric device we used in kilowatts and S is the number of months we operate this device.

In our work these variables are:

T = 1200 JD

C = 0.07 JD.

D = calculated as variable in the table below.

N = 31 days

P = 1.44 kilowatts

S = 4 months per year

And here we show in table 1 the payback period for different working hours for the air conditioning unit assuming that we have 1440 watt unit.

Table 1: payback period for several duration for operation of this system

Duration of operation (hours per day)	Money consumed for electricity per month (JD)	Money consumed per season, 4 months <sup>1</sup> (JD)	Pay back period (years)
10	31.15	124.6	9.6
12	37.38	149.52	8.02
14	43.61	174.44	89

**conclusion:**

The results of the calculations show closed values to the theoretical values that was needed to be obtained, and that shows that the system is working properly and the needed results were obtained.

The main objective of the work is to eliminate the electrical cost used to run the air conditioner.

The output of the PV cells will be 68 V and 6 A ,so we can use our result to run the air conditioner.

<sup>1</sup> Assuming we use the conditioner 4 months a year.

After running our air conditioner the result were as efficient as we want, for example we had a coefficient of performance equals to 5.046 which is very acceptable answer comparing with other air conditioning systems, and we had a refrigeration capacity equals to approximately one fifth ton of refrigeration, knowing that our system is a sample design for an air conditioner; this answer is encourages us to enlarge this system to use it in a bigger volume.

## References

- DayStar Technologies, Inc. (2002) *What is Photovoltaics?*  
[www.daystartech.com/whatpv.htm](http://www.daystartech.com/whatpv.htm) Nov 25, 2003
- Carr A., Fletcher S., O'Mara K., Rayner M. (1999) *The RE-files: photovoltaic solar cells*  
<http://acre.murdoch.edu.au/refiles/pv/text.html> Nov 25, 2003
- ASHRAE (2000) *HVAC Systems and Equipment* (SI edition) Atlanta: American Society of Heating, Refrigerating and Air-conditioning Engineers, Inc (2000 Shrae Handbook)
- ASHRAE (2002) *Refrigeration* (SI edition) Atlanta: American Society of Heating, Refrigerating and Air-conditioning Engineers, Inc. (2002 ASHRAE Handbook)
- Filipe Mendes L., Collares-Pereira M. Ziefler F. (1998) Supply of cooling and heating with solar assisted absorption heat pumps: an energetic approach. *International Journal of Refrigeration* Vol. 21, No. 2, pp. 116-125 ISSN: 0140-7007
- Gordon J., Choon Ng (2000) High-efficiency solar cooling *Solar energy* Vol. 68 No. 1 pp. 23-31 ISSN:0038-092x
- Goswami Y., Kreith F., Kreider J. (1999) *Principles of solar engineering* (2nd ed.) Philadelphia: Taylor & Francis Books Inc. ISBN 1-56032-714-6
- BSR Solar Technologies (2002)  
<http://www.bsrsolar.com> Aug 21, 2003
- Pita Edward G. (1998) *Air-conditioning Principles and Systems* (3rd ed.) Saddle River, N.J: Prentice-Hall Inc. ISBN 0-13-505306-4
- Stoecker W. F., Jones J. W. (1982) *Refrigeration and air conditioning* New York: McGraw-Hill book company ISBN 0-07-061679-1
- IEA (2002) *ONGOING RESEARCH RELEVANT FOR SOLAR ASSISTED AIR CONDITIONING SYSTEMS Technical Report IEA Solar Heating and Cooling Task Solar-assisted air-conditioning of buildings* <http://www.iea-shctask25>.
- Corcoleotes, Williamson J.S. (1982) SOLERAS Solar Cooling Project *ASHRAE Transactions* Vol. 88, Part 1 pp. 1017-1025
- Grossman G. (2002) Solar-Powered systems for cooling, dehumidification and air conditioning *Solar energy* Vol. 72 No. 1 pp. 53-62 ISSN:0038-092x
- Henning H-M. (2000) *Air Conditioning with Solar Energy* presented on the 4<sup>th</sup> transnational SERVITEC project meeting, Barcelona und Almeria (Spain), 30 Sept. to 5 Oct. 2000 Available to public at: <http://www.eduvinet.de/servitec/coolee.htm>
- Solel (2003) *Solar Systems Ltd.*  
<http://www.solel.com> Dec 15, 2003
- Halliday S., Beggs C., Muneer T. (1999) Is solar air conditioning feasible? *Building Research & Information* Vol 27 pp. 149-164
- ASHRAE (2004) *HVAC Systems and Equipment* (SI edition) Atlanta: American Society of Heating, Refrigerating and Air-conditioning Engineers, Inc (2004 Ashrae Handbook)
- Al-Marafie A.M.R., Suri R. K., Maheshwari G. P. (1988) Techno-economic performance analysis of solar cooling systems *International Journal of Energy Research*, Vol. 12, no 3, pp. 393-401