

## Fatigue Life Enhancement of Carbon Steel By Ball Burnishing Process

تحسين عمر الكلال للصلب الكربوني بعملية الصقل بالكرة

A. A. Ibrahim

Assos. Prof., Mech. Eng. Dept., Shoubra faculty of Engineering, Benha University  
108 Shoubra St.- P.C./112411, Cairo, Egypt

### الملخص العربي

عملية الصقل تعتبر عملية نشوه بلاستيكي لأسطح المشغولات. وأصبحت أكثر استخداما لإرضاء الطلبات المتزايدة للحصول على أداء ودقة عالية للأجزاء الميكانيكية. وهكذا، تعتبر الدراسات التي تمكن من الحصول على أفضل متغيرات العملية للحصول على خصائص أسطح جيدة دراسات هامة.

إن هدف هذا البحث هو دراسة تأثير عملية الصقل باستخدام أداة صقل من النوع الكروي على عمر الكلال للصلب الكربوني. وقد أجريت التجارب على مخرطة تعمل بالتحكم العددي CNC لدراسة تأثير متغيرات عملية الصقل وهي قوة الصقل، ومعدل تغذية الصقل على بعض خصائص السطح الناتج للمشغولات مثل خشونة السطح، والصلادة الدقيقة، والتغير في القطر. وأيضا تم دراسة تأثير متغيرات عملية الصقل على عمر الكلال من خلال إختبار الكلال.

وأوضحت النتائج أن قوة الصقل ومعدل التغذية من أهم المتغيرات التي تلعب دورا هاما في التحكم في جميع خصائص السطح الناتج وعمر الكلال.

وقد تم تقديم أفضل معاملات عملية الصقل التي تمكن من الحصول على خشونة سطح منخفضة و تزيد من صلادة السطح وعمر الكلال. وأوضحت الدراسة أيضا بأنه يمكن إطالة عمر الكلال للأجزاء المشغلة عن المعدن الأصلي باستخدام معاملات الصقل الملائمة.

وقد تم الحصول على عمر الكلال الأطول باستخدام قوة تلميع ٢١٠ نيوتن ومعدل تغذية ٠.١٢ ملليمتر/دورة. وعموما فإن الصلادة الدقيقة للسطح المشغل بعملية الصقل تزداد مع زيادة قوة الصقل ومعدل التغذية. وكذلك فإن توزيع الصلادة الدقيقة خلال العمق تحت السطح المشغل بعملية الصقل ومقدار العمق المتأثر يتناسب طرديا مع قوة الصقل.

وقد تم استنتاج أن عمر الكلال للأجزاء المشغلة بعملية الصقل لا يمكن أن يتحدد فقط من مقياس درجة خشونة السطح الناتج أو من قيمة الصلادة الدقيقة للسطح.

## **ABSTRACT**

Burnishing, a plastic deformation process, becomes more popular in satisfying the increasing demands of machine component performance and reliability. Thus, investigating the burnishing parameters in order to improve the product quality is especially crucial.

The objective of this research is to study the effect of burnishing process on fatigue life. Experimental work was carried out on a CNC lathe to study the effect of burnishing parameters; such as, burnishing feed and burnishing force, on some surface characteristics such as; surface roughness, microhardness, and reduction in diameter. Then the effects of the burnishing parameters on the fatigue life are investigated through a fatigue test.

Burnishing force and burnishing feed play an important role in controlling the values of all surface characteristics and fatigue life.

Optimum burnishing parameters are established to minimize roughness and/or maximize surface hardening and fatigue life. It is found that it is possible to get longer fatigue life for machined parts than the virgin material by setting the proper burnishing conditions.

Longer fatigue life is achieved using burnishing force of 210 N and feed rate of 0.12mm/rev. In general the microhardness at the burnished surface increases as the force and feed rate increase. The distribution of microhardness along the depth below burnished surface and its affected depth are directly proportional with the burnishing force.

It is also clearly shown that the fatigue life of burnished materials cannot be determined or explained solely by surface roughness or microhardness.

## **KEYWORDS**

Ball Burnishing, Fatigue life, Surface roughness, Microhardness.

## **1. INTRODUCTION**

The purpose of machining processes is to produce surfaces with the required shape, dimensions, accuracy, and surface roughness. In many cases turning is used as finishing operation in the production of shafts. These components are generally subjected to variable loads and are therefore prone to fatigue failure. Fatigue life is an important dynamic property and it is strongly affected by the surface condition produced during machining or other processing. It is a progressive and permanent structural change that occurs in materials subjected to fluctuating stresses and strains. Cracking or fracture of the component occurs after a sufficient number of fluctuations. In such cases, it is necessary to satisfy given standards of geometrical accuracy and surface roughness for the machined components.

In addition, the reliability or operating life of the machined products must be ensured because the residual tensile stress accelerates the progress of fatigue cracks and the fatigue life of the product is reduced.

The residual stresses left by the turning operation depend both on the type of material being machined and on turning parameters. The optimal setting of process parameters was done to obtain compressive residual stresses (or at least low tensile stresses) might be performed [1].

Several techniques have been developed in order to estimate, qualitatively and quantitatively, the extent of the influence of the machining process and parameters on the properties and service life of the component. Compressive residual stress

distributions were recorded when turning hardened bearing steel, the magnitude and penetration depth of these stresses were much higher when turning using worn inserts compared to new cutting tools [2]. Jeelani [3] showed the effect of cutting speed and tool rake angle on the fatigue life of aluminum alloy compared with the case of the virgin material.

The effect of the machining conditions on the fatigue life was investigated by many authors through a fatigue test using the specimen finished under various cutting conditions. Ibrahim et al [4] showed the fatigue test results of turned 0.12% Carbon steel. The authors reported that, the surface finish after turning operations with the combinations of cutting conditions that were used during turning have great effects on fatigue life. The machined surface property could be controlled by the setting of the cutting conditions to some extent [5]. Dale et al [6] reported that, favorable surface integrity for optimal fatigue life can be produced using small feeds and sharp cutting tools.

As the manufacturing processes influence fatigue performance by affecting the intrinsic fatigue strength of material near the surface, so by introducing or removing residual stress in the surface layers, and by introducing or removing irregularities on the surface that act as stress raisers will affect the fatigue life. Because the fatigue life depends primarily upon cycles to crack initiation, surface enhancement can significantly improve the endurance limit and extend component fatigue life by an order of magnitude [7].

Several studies have been conducted on ball burnishing tools to generate compressive residual stress within the machined surface [8]. On the other hand, the effect of burnishing processes on the fatigue performance of different metals was studied by many authors. One publication [9] investigated this effect on nickel based super alloy IN718, its result

showed the fatigue benefit of thermal stability at engine temperatures. Michael [10] reported that, ball burnishing can be used to induce deep and high magnitude compressive residual stresses in metallic systems and may provide an affordable, high performance process for fretting fatigue enhancement.

Depending on the ball burnishing process parameters and material characteristics, the residual stress state and the corresponding percent cold work (both depth profile and surface distribution) vary as functions of position [9]. These parameters can be selected to optimize the surface characteristics of burnished components [11, 12]. Seemikeri et al [13] reported that, the parameters that have greater influence on the surface roughness and fatigue life response variables in the decreasing order of importance are pressure, speed, ball diameter and number of passes.

Since the burnishing processes are applied only after the machining process, thus reducing efficiency due to an extra operation. In addition, there will be a problem of alignment of the workpiece for burnishing process after previous turning process. For this purpose a simple tool is designed and constructed to carry out the experimental work. This tool has to be installed on center lathe after turning process without releasing the specimen from the chuck. Then the effect of burnishing parameters on surface characteristics and fatigue life will be investigated.

## **2- EXPERIMENTAL PROGRAM**

As mentioned, the main concern of this work is to study the effect of ball burnishing process, to characterize and quantify both surface characteristics and the fatigue behavior of mechanical components. This can be achieved by studying the response ball burnishing parameters as a main factor affecting on

surface characteristics and the fatigue life of components.

The effects of two burnishing parameters; namely; burnishing force and burnishing feed rate, at constant burnishing speed of 65.2 m/min; on surface roughness, reduction in diameter, microhardness, and the fatigue life are comprehensively studied through this work.

The fatigue test specimens are machined first by turning, and then are finished by ball burnishing. The effect of the ball burnishing condition on fatigue life is studied.

### 2.1 Burnishing processes

A simple tool is designed and constructed to carry out the experimental work as shown in Fig.1.

The ball is in solid contact only with the surface to be burnished, and is guided by

and tool position are controlled by the adjustable screw and machine tool slides respectively.

The tested material is carbon steel of 0.18%C. This material is selected because of its importance in industry and its susceptibility to degradation when burnished, through surface and subsurface damage.

The burnishing processes are conducted on test specimens prepared by turning to simulate the service conditions of the components regarding to fatigue life.

Turning and burnishing processes are carried out on a CNC lathe model Daewo Boma 2500 without removing the specimen. The specimens are held in a three-jaw chuck and supported by the tailstock center.

The configuration of the test specimen that produced by turning is as shown in fig.2.

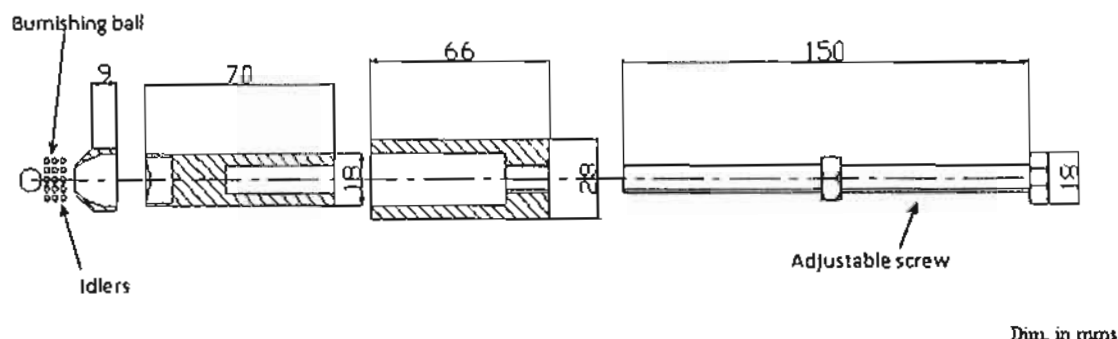

Fig. 1 Construction of burnishing tool

12 idler balls to be free to roll in any direction on the surface of the work piece. Carbon chromium steel 8mm ball diameter of 80 HRC is employed for burnishing process. During processing the suggested tool is mounted on the CNC lathe tool holder in which the tool was properly aligned and leveled.

As shown in the fig. 1, the burnishing tool is ended with a hexagonal head adjustable screw which would be tightened with a torque arm wrench to adjust the required burnishing forces. Then the normal force

The test specimens are annealed for 1 h at 850 °C, and then machined to the desired

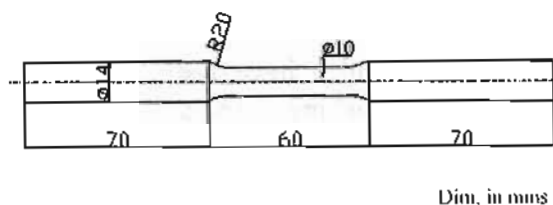

Fig. 2 Geometry of fatigue test specimen

geometry before the burnishing processes.

The turning conditions that were unified for all workpieces are as follows; cutting

speed= 41 m/min., depth of cut =0.3 mm, feed rate= 0.18 mm/rev., and using tool nose radius of 0.2 mm. The surface roughness of the finish turning process is measured for each specimen and is found in the range from 3 to 4 microns (Ra). Also the initial hardness is measured and is found equal approximately 126 HV.

In order to obtain better surface quality, the proper setting of burnishing parameters is crucial before the process takes place. The investigated burnishing conditions are summarized in table 1.

Table 1. Burnishing process conditions

Ball diameter (mm)	8
Burnishing conditions	Lubricated
Burnishing speed (m/min)	65.2
Burnishing force P (N)	90, 150, 210, 270, and 330
Burnishing feed f (mm/rev)	0.09, 0.12, and 0.16

The surface finish of the burnished specimens is measured using Mitutoyo telysurf model 402 series 178. The measurements are carried out across the lay using diamond stylus of radius 2.5 microns and adjusted meter cut-off 0.8 mm. Four readings of surface roughness (measured by Ra) are taken for each specimen, and the average values are calculated.

For accurate calculation of fatigue stress the change in the Workpiece diameter is also measured at different places along each test.

Indentation hardness test is one of the most common procedures for evaluating the mechanical properties of the materials, and is used to monitor processing operations such as cold working. The Vickers microhardness test was employed in this study. The sample testing was carried out using a digital microhardness tester model HWDM-3, provided with a precision microscope that has a magnification of 400X. This tester can show the hardness, obtained by measuring and calculation, on its liquid crystal display. The load selected

for testing is equal to 4.9 N with constant application speed equal to 50  $\mu\text{m/s}$ . The microhardness is measured for the burnished specimen's surface.

The microhardness test across the depth below surface is performed for the specimens exhibits longer fatigue life only. For this test the sample is cut from the burnished specimens by parting off tool. Then it is mounted in a mould and ground using SiC paper and polished with SiO<sub>2</sub> solution to remove the layers affected by parting off.

The measurements are taken across the depth at an incremental of 100 microns starting from the edge of the surface and going to the center. The microhardness at each depth is taken as an average of three readings taken at three different points at that arc. Total penetration of compressed material or altered zone was determined by noting the depth at which the hardness became constant and equal to that of the interior material.

### 2.3 Fatigue Testing:

The tests are performed on the burnished specimens as mentioned above using four-point rotating bending to provide maximum sensitivity to the surface condition. The fatigue test is first applied to specimens that resulting from turning process to compare its results with that of burnished surface. The test is conducted at room temperature at a speed of 1800 r.p.m with a stress amplitude at the surface of the specimen is set to 270.8 MPa which are very close to the fatigue limit of 0.18%C steel. At least three specimens are used to verify the fatigue life for one burnishing condition.

## 3. RESULTS AND DISCUSSION

The influence of the burnishing force on surface roughness and change in diameter is graphically presented in Figs. 3 and 4.

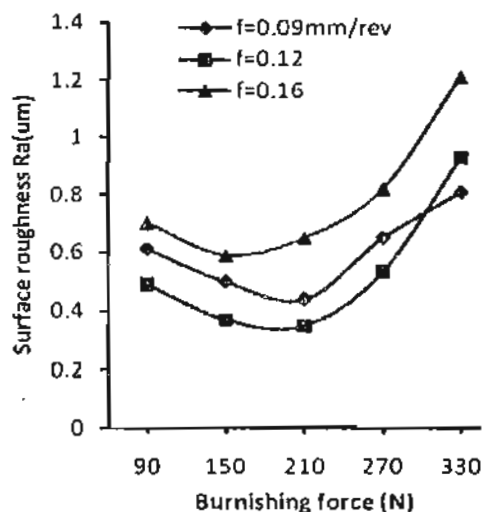

Fig. 3 Effect of burnishing force on surface roughness at different feed rates

As shown in Fig. 3 an increase in burnishing force from 90 to 210 N at feed rates 0.09, and 0.12 mm/rev. leads to a decrease in surface roughness. Then further increase of the force above 210 N leads to an increase of surface roughness at the mentioned feeds. For feed rate of 0.16 the behavior is different as the increase of the force from 90 to 150N decreases the surface roughness, while beyond this value of the force the surface roughness increases as the force increase. This may be because high forces cause gradual shear failure in the subsurface layer which, in turn, causes surface flaking. However the highest surface smoothness is obtained at forces 150N, and 210N at a feed rate of 0.12mm/rev. Further increase in the feed with high force deteriorates the surface finish.

Figure 4 shows the effect of burnishing force on the reduction of diameter. As expected the reduction of diameter increases as the force increases for all values of feeds. The high force increases the ball pressure on the surface that cause compressing of more asperities on the surface. The reduction of diameter is inversely proportional with burnishing feed rate as shown in the figure.

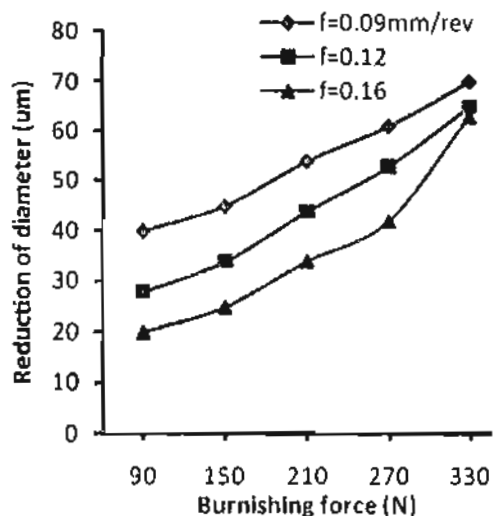

Fig. 4 Effect of burnishing force on reduction of diameter at different feed rates

The increase in burnishing force at different feeds causes an increase in microhardness of the surface layers as shown in Fig. 5. This is obvious because the higher forces cause more plastic deformation. An increase in force (more than 270 N) at high feed rate causes an increase of undeformed material ahead of the ball which decreases the ball pressure into the work surface.

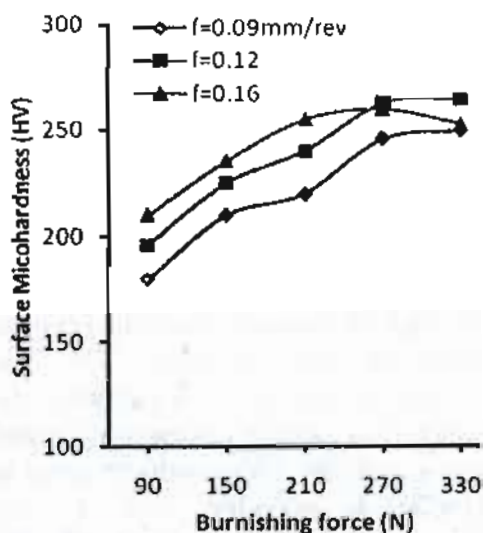

Fig. 5 Relation between burnishing force and microhardness at different feed rates

On the other hand, an increase in feed rate at the upper limits of the force leads to considerable reduction in surface hardness.

Refer to figures 3 and 5 it can be notice that, the optimum combination of smoothness and microhardness occurred when the tool rolled across the specimen surfaces with a feed rate 0.12 mm/rev, with a burnishing force of 210N.

Fig. 6 shows the relationship between burnishing force and fatigue life for different feed rates. Generally, it is said that, the fatigue life of burnished specimens is much higher than the virgin

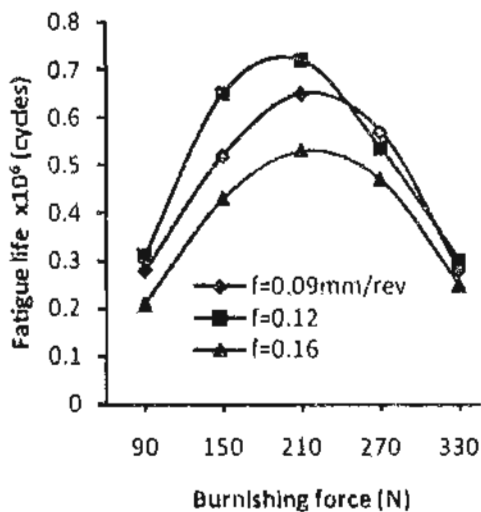

Fig. 6 Relation between burnishing force and fatigue life at different feed rates

material (92562 cycles). The maximum fatigue life enhancement is observed up to 723116 cycles which is 7.8 times more than virgin material.

In all the experimental runs, fatigue life improvement is evident, which is measured in terms of number of cycles, though the magnitude which is varied in each case depending upon the level of factors and their interactions. As the increasing of force from 90 to 210N increases fatigue life. Beyond this value of the force the fatigue life decreases as the force increases. In order to explain those behaviors consider fig. 3 with fig. 5. The increasing of the force from 90 to 210N

decreased the surface roughness for all values of feed. This in turn delays the crack initiation and consequently increases the fatigue life. The increase of the force above 210N increases the surface roughness which accelerates the initiation of a crack, in turn decreasing the fatigue life.

Refer to fig.5, and fig.6 it can be noticed that, although the maximum surface hardness is obtained at the burnishing force of 330, the fatigue lives obtained at this force is not the maximum. This can be attributed to the high surface roughness obtained at this force value which leads to crack initiation. The high hardness values obtained at this force also increases the brittleness that consequently increases the crack propagation.

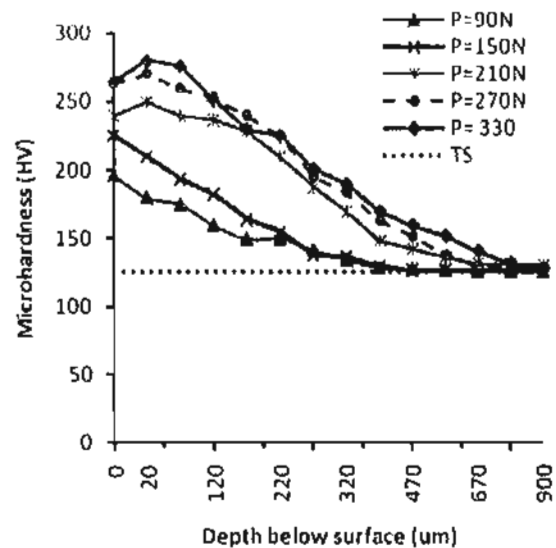

TS ...Turned specimen

Fig. 7 Distribution of microhardness along the depth below burnished surface for feed= 0.12mm/rev.

Comparing fig.3, fig5, and fig.6 it can be noticed that, it is not necessary that the lower surface roughness and higher values of surface hardness always yield higher fatigue life. It is also clearly shows that the fatigue life of machined materials cannot be determined or explained solely by surface roughness and microhardness. This result means that it is possible to get

longer fatigue life, better surface roughness, and high surface hardness for burnished components than the virgin material by carefully setting the proper burnishing conditions.

Fig. 7 shows the distribution of microhardness along the depth below burnished surface for different burnishing forces for the specimen exhibited longer fatigue life i.e. for feed = 0.12mm/rev. It can be seen that, the microhardness of burnished specimens is much higher than the virgin material (126 HV). The maximum microhardness is observed up to 280 HV, with a burnishing force of 330N. The microhardness and also its affected depth increase as the force increases.

### CONCLUSIONS

Experimental results show that burnishing force and feed rate play a significant role in controlling the surface characteristics. In general, the surface roughness and microhardness increase as the feed rate and burnishing force are increased.

The best surface roughness is obtained with a burnishing force of 210N, and feed rate of 0.12mm/rev.

In all experiments, fatigue life is improved by burnishing process relative to turned specimen. Longer fatigue life is achieved using burnishing force of 210 N and feed rate of 0.12mm/rev.

In general the microhardness at the burnished surface increases as the force and feed rate increase. The distribution of microhardness along the depth below burnished surface and its affected depth are directly proportional with the burnishing force.

It is also clearly shows that the fatigue life of burnished materials cannot be determined or explained solely by surface roughness or microhardness.

### REFERENCES

- 1] Edoardo Capello "Residual stresses in turning Part I: Influence of process parameters" Journal of Materials Processing Technology 160, pp (221-228). (2005).
- 2] Alexandre M. Abro, and David K. Aspinwall "The surface integrity of turned and ground hardened bearing steel" Wear 196, pp(279-284). (1996).
- 3] S. Jeelani, and M. Musial. "Effect of cutting speed and tool rake angle on the fatigue life of 2024-T351 aluminum alloy", Int. J. Fatigue 6 (3), pp(169-172). (1984).
- 4] A. A. Ibrahim, F. S. Ahmed, K. ELshazly, and S. Samir "Effect of cutting condition in turning on fatigue behavior of 0.12% carbon steel" Fourth Assiut University Int. Conf. on Mech. Eng. Advanced Tech. For Indus. Prod.(MEATIP4), pp(578- 598). December 12-14 (2006).
- 5] Hiroyuki Sasahara "The effect on fatigue life of residual stress and surface hardness resulting from different cutting conditions of 0.45%C steel" International Journal of Machine Tools & Manufacture 45, pp(131-136). (2005).
- 6] Dale W. Schwach, and Y.B. Guo Reported "Feasibility of producing optimal surface integrity by process design in hard turning" Materials Science and Engineering A 395, pp(116-123). (2005).
- 7] Paul S. Prevéy, Michael J. Shepard, and Paul R. Smith, "THE EFFECT OF LOW PLASTICITY BURNISHING (LPB) ON THE HCF PERFORMANCE AND FOD RESISTANCE OF TI-6AL-4V", Proceedings: 6th National Turbine Engine High Cycle Fatigue (HCF) Conference, Jacksonville, FL, March 5-8, (2001).
- 8] F. Klocke, and J. Liermann, "Roller burnishing of hard turned surfaces", International Journal of Machine Tools and Manufacture 38, pp(419-423) (1998).
- 9] Paul S. Prevéy, Ravi A. Ravindranath, Michael Shepard, and Timothy Gabb "Case Studies of Fatigue Life Improvement Using Low Plasticity Burnishing in Gas Turbine Engine Applications", Proceedings of ASME Turbo Expo 2003, 10 pages, Atlanta, Georgia, USA, June 16-19, 2003.



- 10] Michael J. Shepard, Paul S. Prev y, and N. Jayaraman "*Effects of Surface Treatment on Fretting Fatigue Performance of Ti-6Al-4V*" 8th National Turbine Engine HCF Conference, 10 pages, April 14-16 (2003).
- 11] A. M. Hassan, H. F. Al-Jalil, A. A. Ebied, "*Burnishing force and number of ball passes for the optimum surface finish of brass components*". J. Materials Processing Technology. 83, pp(176-179), (1998).
- 12] M. H. El-Axir, and A. A. Ibrahim, "*Some surface characteristics due to center rest ball burnishing*" J. Materials Processing Technology. 167(1), pp (47-53), c(2005).
- 13] C.Y. Seemikeri, P.K. Brahmankar, S.B. Mahagaonkar "*Investigations on surface integrity of AISI 1045 using LPB tool*" Tribology International 41, pp(724-734), (2008).