

# A New Design of Magnetic Gear for Wind Turbine

## تصميم جديد لناقل مغناطيسي لطاحونه الرياح

E. GOUDA.

Electrical Engineering Department, Mansoura University, Mansoura 35516, Egypt.

Eid.gouda@yahoo.fr

### الخلاصة:

من الواضح ان مشكلة الطاقه تعد من اكبر المشاكل التي تواجه عالمنا في المستقبل القريب. ولحل هذه المشكله فكان علينا ان نجد مصادر جديده للطاقه او نرفع من كفاءه المصادر الحاليه. وتعد طاقة الرياح من مصادر الطاقه الجديده الواعده. فمن المعروف ان طاحونه الرياح تستخدم النواقل الميكانيكيه لكي تنقل العزم الميكانيكي والسرعه للمولد الكهربى. حيث وجد ان جميع انواع النواقل الحاليه لها عديد من العيوب مثل الفقد الكبير في الطاقه والضوضاء العاليه والحاجه المستمره الي الصيانه وحجمها الكبير. ففي هذا البحث نقدم تصميم جديد لناقل مغناطيسي بدلا من الناقل الميكانيكي لطاحونه الرياح لتلافي معظم العيوب السابقه. حيث ان الناقل المقترح بلا احتكاك ولا ضوضاء وحجمه صغير وكفاءته عاليه ويمكن الاعتماد عليه.

### ABSTRACT:

It is clear that the problem of energy is the biggest problem faces our world in the near future. To solve this problem the world has to develop new energy sources or increase the efficiency of the existing ones. The wind energy is considered as one of the most promising renewable energy resources. The wind turbine uses mechanical gears to transfer the mechanical torque and speed to the generator unit. The existing types of gear have many disadvantages such as higher energy loss and higher acoustic noise, need frequently maintenance, need higher volume. This paper presents a new design of a magnetic gear for the wind turbine that replaces the existed mechanical gear and avoids most of the above problems. The proposed magnetic gear has free friction, no acoustic noise, and minimum volume. It is reliable and more efficient.

*Index Terms*—Wind Turbine, Mechanical Gear and Magnetic Gear.

## I. INTRODUCTION

ENERGY is considered as one of the important thing in our life. Always scientific researchers work to find new renewable resources of energy, to save their life in this plant, or to improve the efficiency of the existing resources. Wind turbines are considered one of these resources. In this paper the author presents a new design of wind turbine to improve the efficiency of this unit.

It is known that the wind turbines use mechanical gears to transmit the speed and torque from the wind blade to the electrical generator [1]-[3]. The mechanical gear boxes have many problems such as contact friction, noise, and heat. Magnetic gears boxes may be the best solutions for these problems. The construction and theory of operations for

different magnetic gears were described in [4]-[9]. Gouda et al [8] introduced comparative study between mechanical and magnetic planetary gears and they proved that the magnetic gears have better performances and smaller volumes than the mechanicals ones. Also the magnetic gears are used in the hybrid vehicle systems to improve their efficiency [10].

The above researches prove the ability of magnetic gear to solve most of the mechanical problems and save energy at the same time. In this paper, the author proposes a new efficient design of magnetic gear with the wind turbine. This gear will be integrated with the electrical generator. The system configurations are given in section II. The design of the integrated gear and its simulation by 2D finite element software are given in section III. The

performance of the proposed gear system and discussion of the output results are given in section IV.

## II. SYSTEM CONFIGURATIONS

Figure 1.a shows the conventional basic configuration of wind turbine blade with a mechanical gear and electrical generator. The function of gear box mainly is to connect the low speed wind blade with the high speed generator. The electrical output of the generator is modified by series of rectifier and converter to make the frequency of the output voltage is identical with the frequency of the electrical grid [11].

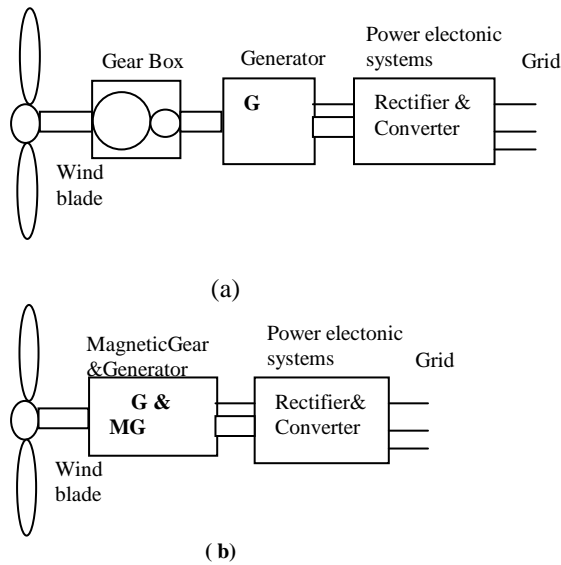

Fig. 1. Wind power generation systems. (a) Conventional. (b) Proposed

The proposed system where the gear and generator are integrated in one unit and shown in Figure 1.b. The proposed system has small volume and higher efficiency. The proposed system contains a magnetic gear instead of mechanical one which is located in the generator.

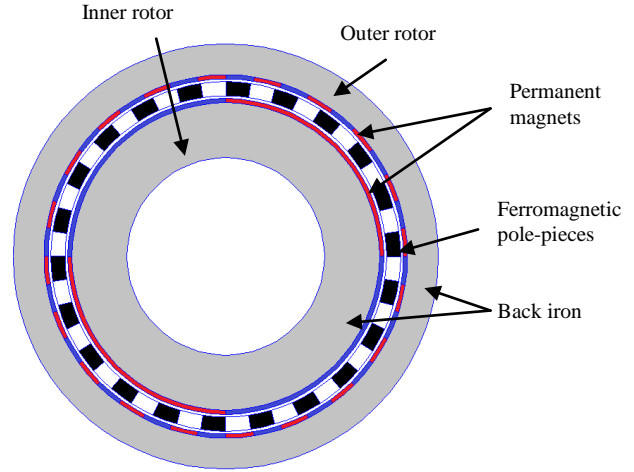

Fig. 2. The magnetic gear

### A. The magnetic gear

The Representation of the magnetic gear is shown in Figure 2. It contains three rotors. The middle one is always fixed and carries  $n_s$  ferromagnetic pole-pieces. The inner and outer rotors carry  $p_2$  and  $p_3$  pole-pairs of permanent magnet respectively [4]. The highest torque transmission capability of the gear is obtained with the combination [4].

$$p_3 = n_s - p_2 \quad (1)$$

The gear ratio  $Gr$  when the middle rotor is fixed can be calculated by (2).

$$G_r = \frac{p_3}{p_2} = -\frac{\Omega_2}{\Omega_3} = \frac{T_3}{T_2} \quad (2)$$

Where  $\Omega_2$  and  $\Omega_3$  are the angular velocities of inner and outer rotors respectively,  $T_2$  and  $T_3$  are also the torques of inner and outer rotors respectively.

### B. Permanent magnet synchronous generator

In this paper the electrical generator used (Fig. 3) with the wind turbine is called permanent magnet synchronous generator PMSG. It contains two parts stator and rotor. The stator carries 3 phase windings distributed in number of slots. The rotor carries number of  $p_1$  permanent magnet pole-pairs. When the

rotor is driven at speed  $\Omega_1$  by mechanical source, an induced voltage will be generated in the stator winding with  $f$  frequency calculated by (3).

$$f = \Omega_1 \frac{p_1}{60} \quad (3)$$

The main goal of the designers is to make the frequency of the output voltage of the generator equals to the frequency of the electrical grid (50 Hertz). It is known that the speed of the wind is very slow (about 150 rpm). By using the conventional generators ( $p_1=2$ ) one can calculate the output frequency from (3). It is about 5 Hertz which is very small. Gear box with gear ratio 10 should be used to increase the speed ten times to obtain the required 50 Hertz for the grid.

### C. Integrated magnetic gear with the generator

The objective of this paper not only to replace the mechanical gear by a magnetic one but also to make the two systems magnetic gear and generator (Fig. 2 and 3) in one machine (Fig.4). This unit will be smaller and cheaper than two separated systems.

In the new system, the magnetic gear is outside whereas the generator is inside (Fig.4). The low speed wind turbine blade will be connected with the outer rotor of the magnetic gear. The inner rotor of the magnetic gear and the outer rotor of the generator are combined in one frame rotor which has the same speed. Then  $\Omega_1$  equals  $\Omega_2$ . The stator of generator is connected directly to the electrical grid without changing the frequency if magnetic gear ratio is about 10 as mentioned before.

## III. MACHINE DESIGN AND FINITE ELEMENT SIMULATION

From (1) and (2) one can obtain the required gear ratio  $Gr$  (about 10). There are many combinations of  $p_3$ ,  $p_2$  and  $n_s$ . The best one that

introduces minimum torque ripple is  $p_3=20$ ,  $p_2=2$  and  $n_s=22$  [12].

The parameters of the studied integrated machine are shown in Table I. A 2-dimensionnal magnetostatic finite element analysis [13] has been carried out in order to simulate the integrated machine. For the given design parameters (Table I) the magnetic field distributions are carried out by the simulation and given by (Fig.5).

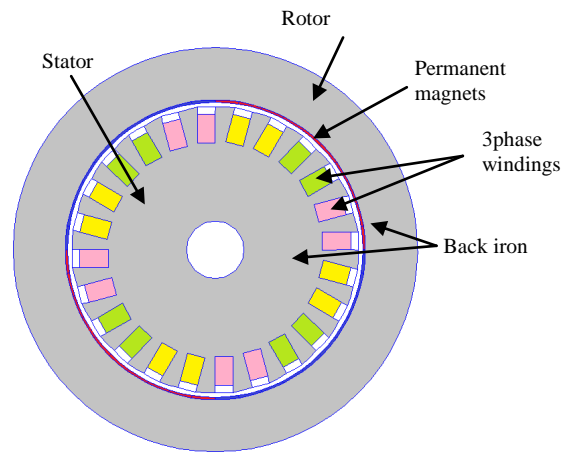

Fig. 3. Proposed Permanent magnet synchronous generator

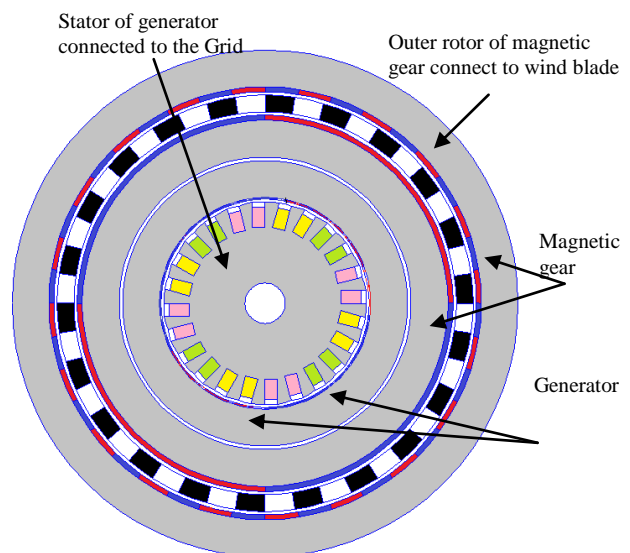

Fig. 4. Proposed integrated magnetic gear with the generator

TABLE I  
PARAMETERS OF THE STUDIED INTEGRATED MAGNETIC GEAR

Description	Value
Number of stator slot	24
Number of conductors per slot	46
External radius of stator (Generator)(mm)	60
External radius of rotor (Generator)(mm)	85
PM thickness(Generator) (mm)	1
External radius of back-iron in the inner rotor(Gear) (mm)	109
Inner radius of outer rotor(Gear) (mm)	126
External radius of outer rotor(Gear) (mm)	151
Shaft radius (mm)	20
Inner rotor PM thickness(Gear) (mm)	3
Air-gap (mm)	2
Outer rotor PM thickness(Gear) (mm)	3
Axial length (mm)	100
Permanent magnet remanence (T)	1.25

#### IV. PERFORMANCES OF THE PROPOSED MACHINE

The instantaneous torque for each rotor is shown in Fig. 6. From the results, it is clear that all average torques are nonzero values which mean that there is a successful energy conversion from the wind blade to the magnetic gear and the generator. One notes that the ratio of the average input torque to the output torque of the magnetic gear (228/24) equals 9.5 which is nearly equals the designed magnetic gear ratio( $G_r=10$ ). The difference between the output average torque of the gear (24Nm) and the input average torque of the generator (29Nm) is due to the high values of the cogging and ripple torque for the PMSG. The cogging torque is considered the main disadvantages of PMSG. It is expressed as the change of the torque on rotor in interaction of magnet flux and stator teeth. It cases noise and vibrations for the machine. There are many ways to reduce its value: by using fractional number of slot per pole per phase, using skewing for stator and rotor or by changing opening slot [14]-[15].

The output phase currents are shown in Fig7. The rms value of output current is about 15 Amp, and it's frequency about 50 Hertz. The

machine can be connected directly to the grid without needing the converter unit. It is clear that the proposed system is more compact and can save energy and money.

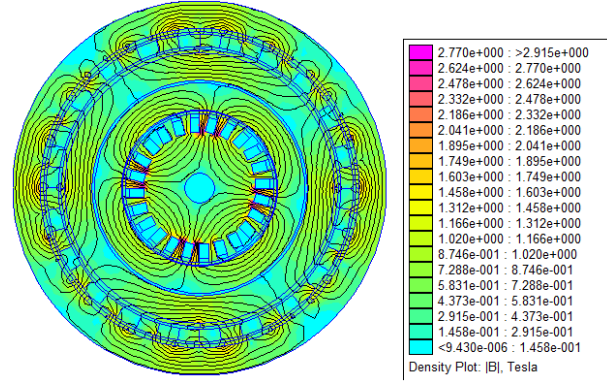
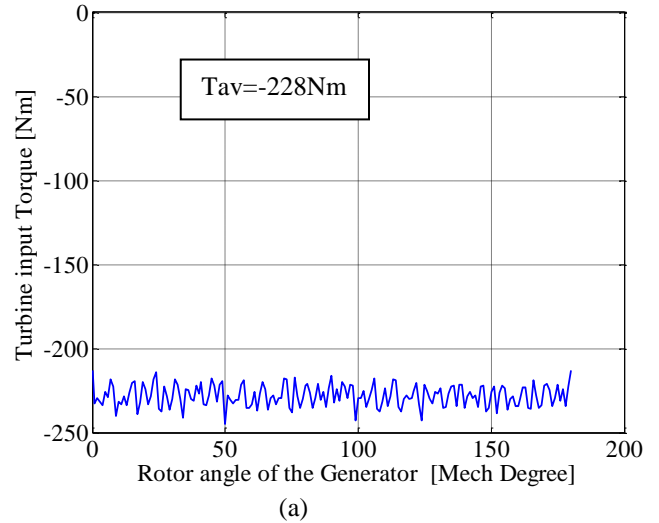

Fig.5 The distribution of magnetic flux in machine cross-section



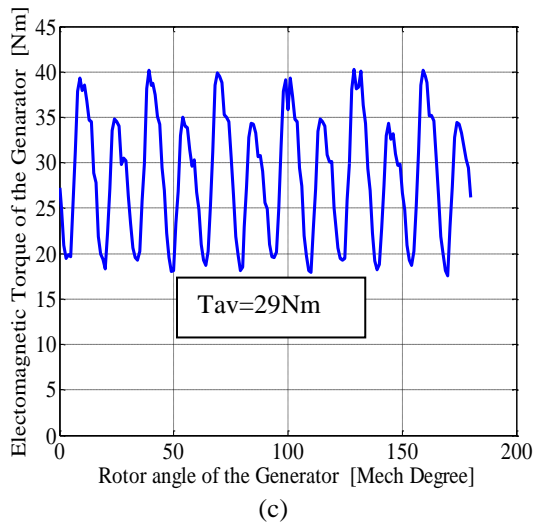
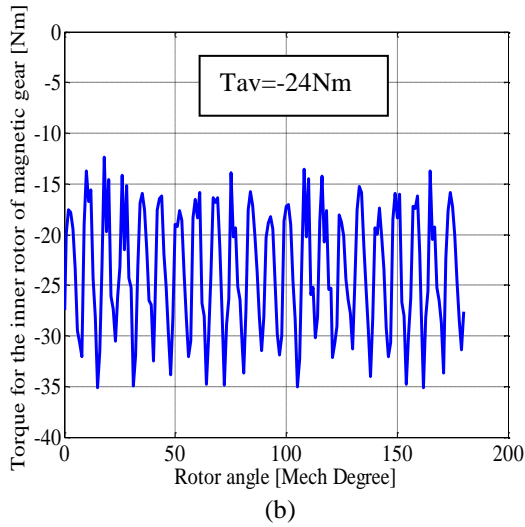
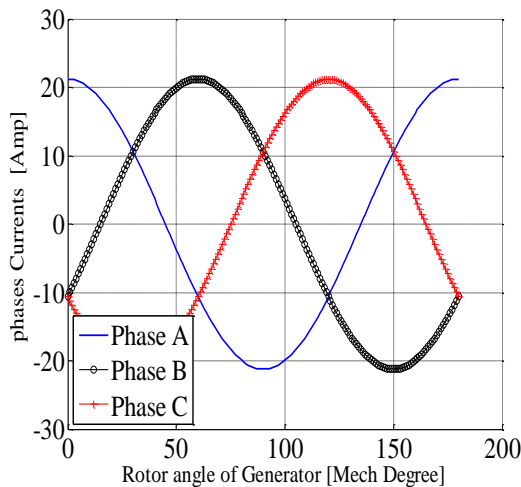

Fig.6 Torques in different rotors of the Gear with rotor angle.



## V. CONCLUSION

The main objective of this work is to reduce the energy loss and cost of wind turbine gear box. The author proposed not only using magnetic gear instead of the mechanical one but also to integrate the gear and generator in one unit. The proposed system becomes smaller and cheaper. The design and simulation results were given. The proposed magnetic gear has free friction, no acoustic noise, and minimum volume. It is reliable and more efficient. It leads to save the energy loss and money.

## REFERENCES

- [1] M. Adam and M. Ragheb (2011)., “Wind Turbine Gearbox Technologies, Fundamental and advanced Topics in Wind Power,” Dr. Rupp Carriveau (Ed.), ISBN: 978-953-307-508-2, InTech, Available from: <http://www.intechopen.com/books/fundamental-and-advanced-topics-in-wind-power/wind-turbine-gearboxtechnologies>
- [2] T., Sharpe, D, Jenkins, N, Bossany(2004). “Wind Energy Handbook (3rd Ed.) ”. John Wiley & Sons Ltd., ISBN: 0-471-48997-2, West Sussex, England.
- [3] A. Ragheb, , M. Ragheb(2010). “Wind Turbine Gearbox Technologies,” Proceedings of the 1st International Nuclear and Renewable Energy Conference (INREC’10), ISBN: 978-1-4244-5213-2, Amman, Jordan, March 2010.
- [4] K. Atallah S. Calverley, and D. Howe, “Design, analysis and realisation of high-performance magnetic gear,” *IEE Proc. Electr. Power Appl.*, vol. 151, no. 2, pp. 135-143, March 2004.

- [5] P. O. Rasmussen, T. O. Andersen, F. T. Jorgensen, and O. Nielsen, "Development of a high-performance magnetic gear," *IEEE Trans. Ind. Appl.*, vol. 41, no. 3, pp. 764–770, May/June 2005.
- [6] S. Mezani, K. Atallah, and D. Howe, "A high-performance axial-field magnetic gear," *J. Appl. Phys.*, vol. 99, 08R303, 2006.
- [7] L. Jian, K. T. Chau, Y. Gong, J. Z. Jiang, C. Yu, and W. Li, "Comparison of Coaxial Magnetic Gears With Different Topologies," *IEEE Trans. Magn.*, vol. 45, no. 10, pp. 4526–4529, Oct. 2009.
- [8] E. Gouda, S. Mezani, L. Baghli, and A. Rezzoug, "Comparative Study Between Mechanical and Magnetic Planetary Gears," *IEEE Trans. Magn.*, vol. 47, no. 2, pp. 439–450, Feb. 2011.
- [9] T. Lubin, S. Mezani and A. Rezzoug " Experimental and Theoretical Analysis of Axial Magnetic Coupling under Steady-State and Transient Operation", *IEEE Trans. Industrial Electronics.*, vol. PP, no. 99, 2013
- [10] L. Baghli, E. Gouda, S. Mezani, A. Rezzoug, "Hybrid vehicle with a magnetic planetary gear", *EFEEA'10 International Symposium on Environment Friendly Energies in Electrical Applications*, 2-4 November 2010, Ghardaïa, Algeria
- [11] Jianguo Li, K. T. Chau, J. Z. Jiang, Chunhua Liu, and Wenlong Li, " A New Efficient Permanent-Magnet Vernier Machine for Wind Power Generation", *IEEE Trans. Magn.*, vol. 46, no. 6, pp. 3802–3809, 2010.
- [12] Z. Q. Zhu, and D. Howe, "Influence of Design Parameters on Cogging Torque in Permanent Magnet Machines," *IEEE Trans. Energy Conv.*, vol. 15, no. 4, pp. 407–412, December 2000.
- [13] D. C. Meeker, *Finite Element Method Magnetics*, Version 4.2 (02 Nov. 2009 Build), <http://www.femm.info>
- [14] L. Dosiak, P. Pillay, "Cogging torque reduction permanent magnet machine", *IEEE Transactions on industry applications*, vol. 43, no. 6. pp. 1656–1571, 2007. [Online]. Available:<http://dx.doi.org/10.1109/TIA.2007.908160>
- E. Muljadi, J. Green, "Cogging torque reduction in a permanent magnet wind turbine generator", in *Proc. of the 21 st American Society of Mechanical Engineers Wind Energy Symposium*, pp.1–8, 2002